

Memo

Carmichael



RECREATION AND
PARK DISTRICT

To: Advisory Board of Directors

From: Mike Blondino, District Administrator
James Perry, Park Services Manager
Ingrid Penney, Administrative Services Manager

Date: June 22, 2023

Subject: Award the Bid for the La Sierra Community Center (LSCC) Roof Coating Improvement Project; enter into Contract #23-0004

Introduction/Discussion:

At the March 16, 2023 Regular Meeting, the Advisory Board voted to approve and recommend a Capital Project List (CIP) as part of the Recommended Budget for FY2023-24 using funds from the voter approved 2022 General Obligation Bonds, Series 2023 A-1 (Tax Exempt) and A-2 (Taxable). The recommendation included an authorization for the District Administrator to initiate Request for Proposals as required or necessary.

On June 7, 2023, the Board of Supervisors adopted the Fiscal Year 2023-24 Recommended Budget and CIP. The LSCC Roofing Coating Project was identified on the CIP List using funds from the Bond Series 2023 A-2.

On May 5, 2023, a Notice – Request for Bid Proposals was advertised. Bid openings were held on June 6, 2023. The following two firms submitted proposals:

- Brazos Urethane, Inc. with a bid in the amount of \$823,872
- Madsen Roofing & Waterproofing, Inc. with a bid in the amount of \$338,797

Staff performed due diligence, reviewing the bids for responsiveness. The bid received from Madsen Roofing & Waterproofing, Inc. was complete and under the estimated cost of \$800,000 included in the budget. Madsen Roofing & Waterproofing, Inc. has performed other projects for the CRPD.

The bid items were for roof improvements located at the 200 Wing (full) , 300 (East), 400 (East), 500 Wing (full), and 600 (West), representing some of most critical problem areas. These Wings are leased by the California Montessori Project, Inc. (CMP). With the CMP school year over, Staff has timed the project to take advantage of their off season and when CRPD funding becomes available in July.

RECOMMENDATION:

Staff recommends approval by the Advisory Board, to award the bid from Madsen Roofing & Waterproofing, Inc. as the lowest responsible bidder and enter into Contract #23-0004 in the amount of \$338,797 for the Roof Coating Improvement Project at the La Sierra Community Center; delegating authority to the District Administrator or designee to execute the Contract.

Attachments:

Extracts from Bid Package –

Bid Items

Sample Agreement

FIRM NAME _____

CRPD CONTRACT NO. 23-0004

**CARMICHAEL RECREATION AND PARK DISTRICT
BID FORM**

CRPD CONTRACT NO. 23-0004

**LA SIERRA COMMUNITY CENTER
ROOF COATING IMPROVEMENT PROJECT**

BID ITEMS

Materials in compliance with La Sierra Construction Documents for the following line Items:

BID ITEM Full 200 Wing	QTY.	UNIT	COST
Preparation, mobilization, cleaning and preparation, installation of silicone roof coating with 15-year warranty	22,848+-	SF	

BID ITEM 300 East	QTY.	UNIT	COST
Preparation, mobilization, cleaning and preparation, installation of silicone roof coating with 15-year warranty	7,200+-	SF	

BID ITEM 400 East	QTY.	UNIT	COST
Preparation, mobilization, cleaning and preparation, installation of silicone roof coating with 15-year warranty	7,200+-	SF	

BID ITEM Full 500 Wing	QTY.	UNIT	COST
Preparation, mobilization, cleaning and preparation, installation of silicone roof coating with 15-year warranty	14,400+-	SF	

BID ITEM 600 West	QTY.	UNIT	COST
Preparation, mobilization, cleaning and preparation, installation of silicone roof coating with 15-year warranty	7,200+-	SF	

(THE REMAINDER OF THIS PAGE INTENTIONALLY LEFT BLANK)

**SUBMIT THIS SHEET AS PART OF YOUR BID SHEET
BID SHEET 2 OF 5**

**SAMPLE AGREEMENT FOR
CARMICHAEL RECREATION AND PARK DISTRICT
[PROJECT NAME] IMPROVEMENT PROJECT**

THIS AGREEMENT is made and entered into on ___ of _____, 2023, by and between the **CARMICHAEL RECREATION AND PARK DISTRICT**, a park district existing under authority of Public Resources Code Section 5780 et seq., hereinafter referred to as “DISTRICT”, and [NAME]., a [TYPE], hereinafter referred to as “CONTRACTOR.”

RECITALS

WHEREAS, the Advisory Board of Directors for DISTRICT (“Advisory Board”) heretofore caused plans and specifications for the work hereinafter mentioned to be prepared, and therefore did approve and adopt said plans and specifications; and

WHEREAS, the Advisory Board did cause to be published for the time and in the manner required by law, a Notice inviting sealed bids for the performance of said work; and

WHEREAS, CONTRACTOR, in response to such Notice, submitted to the Advisory Board within the time specified in said Notice, and in the manner provided for therein, a sealed bid for the performance of the work specified in said plans and specifications, which said bid and proposal, and the other bids and proposals submitted in response to said Notice, the Advisory Board opened and canvassed in the manner provided by law; and

WHEREAS, CONTRACTOR was the lowest responsible bidder for the performance of said work, and said Advisory Board as a result of the canvass of said bids, did determine and declare Contractor to be the lowest responsible bidder for said work and award to a contract therefor; and

WHEREAS, CONTRACTOR has proposed to provide the requested services for the compensation to be provided herein; and

WHEREAS. District has adhered to and/or complied with all applicable provisions of the Public Contract Code (“PCC”), commencing with P.C.C. §20100, et seq., for the construction of public works, where applicable; and

WHEREAS, pursuant to Government Code Section 31000, the DISTRICT is authorized to contract for specific special services with persons specially trained, experienced, and competent to perform such services; and

WHEREAS, pursuant to Resolution #2017-0010, the Sacramento County Board of Supervisors authorized DISTRICT to execute construction agreements; and

WHEREAS, DISTRICT and CONTRACTOR desire to enter into this Agreement on the terms and conditions set forth herein.

NOW, THEREFORE, in consideration of the mutual promises hereinafter set forth, DISTRICT and CONTRACTOR agree as follows:

1. CONTRACT DOCUMENTS

The following documents are by this reference incorporated in and made a part of this Agreement: The Standard Construction Specifications adopted by the Sacramento County Board of Supervisors on July 17, 2001, revised March, 2004; the Special Provisions; 2 copies of contract drawings, if applicable, all addenda; the Notice to Contractors; the Proposal; all required bonds; and all supplemental Agreements covering alterations, amendments, or extensions to the contract. The documents which describe the work to be performed are sometimes collectively referred to herein as the Plans and Specifications. In the case of conflicting documents this agreement takes precedent over all others.

2. SCOPE OF WORK

That the Contractor will furnish all labor, materials, services, transportation, appliances, and mechanical workmanship required for Contract No. 23-, as provided for and set forth in said plans and specifications, Exhibit A, which is attached hereto and incorporated herein or in either of them, which said plans and specifications are hereby referred to and by such reference incorporated herein and made a part of this Agreement. All of the said work done under this Agreement shall be under the supervision of and performed to the satisfaction of the Project Manager of who shall have the right to reject any and all materials and supplies furnished by the Contractor which do not comply with said plans and specifications, together with the right to require the Contractor to replace any and all work furnished by the Contractor which shall not either in workmanship or material be in strict accordance with said plans and specifications.

3. TERM

This Agreement shall be effective and commence as of the date first written above and shall remain in effect until all services covered by this Agreement are completed, which is estimated to be [DATE]. DISTRICT'S Administrator is authorized to amend this Agreement to extend the term. Said work shall be completed and ready for acceptance pursuant to Section 7 of the Standard Specifications,

4. PAYMENT

Attached hereto as Exhibit "D" and by reference made a part hereof, is the bid and proposal of Contractor. Said bid and proposal containing, as required by the terms of said specifications, the full and complete schedule of the different items with the lump sums or unit prices as so specified. The agrees, in consideration of the work to be performed herein and subject to the terms and conditions thereof, to pay Contractor all sums of money which may become due to Contractor in

accordance with the terms of the aforesaid bid and proposal, and this Agreement, to wit: Said sum shall be paid in accordance with Sections 8 of the Standard Specifications. With respect to that portion of the above sum as is based upon the estimated quantities specified for the general scope of the work to be performed herein, actual payment will be based upon the quantities as measured upon completion. No payment made under this Agreement shall be construed to be an acceptance of defective work or improper materials.

5. NOTICE

Any notice, demand, request, consent, or approval that either party hereto may or is required to give the other pursuant to this Agreement shall be in writing and shall be either personally delivered or sent by mail, addressed as follows:

TO DISTRICT:

Attn: Mike Blondino,
District Administrator
Carmichael Recreation & Park District
5750 Grant Ave.
Carmichael, CA 95608

TO CONTRACTOR:

ATTN
COMPANY NAME
STREET ADDRESS
CITY, STATE, ZIP
EMAIL ADDRESS

Either party may change the address to which subsequent notice and/or other communications can be sent by giving written notice designating a change of address to the other party, which shall be effective upon receipt.

6. COMPLIANCE WITH LAWS

CONTRACTOR shall observe and comply with all applicable Federal, State, and County laws, regulations, and ordinances.

7. GOVERNING LAWS AND JURISDICTION

This Agreement shall be deemed to have been executed and to be performed within the State of California and shall be construed and governed by the internal laws of the State of California. Any legal proceedings arising out of or relating to this Agreement shall be brought in Sacramento County, California.

8. LICENSES, PERMITS AND CONTRACTUAL GOOD STANDING

A. CONTRACTOR shall possess and maintain all necessary licenses, permits, certificates and credentials required by the laws of the United States, the State of California, County of Sacramento and all other appropriate governmental agencies, including any certification and credentials required by DISTRICT. Failure to maintain the licenses, permits, certificates, and credentials shall be deemed a breach of this Agreement and constitutes grounds for the termination of this Agreement by DISTRICT.

- B. CONTRACTOR further certifies to DISTRICT that it and its principals are not debarred, suspended, or otherwise excluded from or ineligible for, participation in federal, state or DISTRICT government contracts. CONTRACTOR certifies that it shall not contract with a subcontractor that is so debarred or suspended.

9. PREVAILING WAGES

Pursuant to the provisions of Articles 1 and 2 of Chapter 1, Part 7, Division II, of the Labor Code of the State of California, not less than the general prevailing rate of per diem wages, and not less than the general prevailing rate of per diem wages for holidays and overtime work, for each craft, classification or type of worker needed to execute the work contemplated under this Agreement shall be paid to all workers, laborers and mechanics employed in the execution of said work by Contractor, or by any subcontractor doing or contracting to do any part of said work. The appropriate determination of the Director of the California Department of Industrial Relations is filed with, and available for inspection at, the office of the Clerk of the Governing Board. Contractor shall post, at each jobsite, a copy of such prevailing rate of per diem wages as determined by the Director for the California Department of Industrial Relations.

10. PERFORMANCE STANDARDS

CONTRACTOR shall perform its services under this Agreement in accordance with the industry and/or professional standards applicable to CONTRACTOR'S services.

11. OWNERSHIP OF WORK PRODUCT

All technical data, evaluations, plans, specifications, reports, documents, or other work products developed by CONTRACTOR provided hereunder shall be the exclusive property of DISTRICT and shall be delivered to DISTRICT upon completion of the services authorized hereunder. CONTRACTOR may retain copies thereof for its files and internal use. Publication of the information directly derived from work performed or data obtained in connection with services rendered under this Agreement must first be approved in writing by DISTRICT. DISTRICT recognizes that all technical data, evaluations, plans, specifications, reports, and other work products are instruments of CONTRACTOR'S services and are not designed for use other than what is intended by this Agreement.

12. STATUS OF CONTRACTOR

- A. It is understood and agreed that CONTRACTOR (including CONTRACTOR'S employees) is an independent contractor and that no relationship of employer-employee exists between the parties hereto. CONTRACTOR'S assigned personnel shall not be entitled to any benefits payable to employees of DISTRICT. DISTRICT is not required to make any deductions or withholdings from the compensation payable to CONTRACTOR under the provisions of this Agreement; and as an independent contractor, CONTRACTOR hereby indemnifies and holds

DISTRICT harmless from any and all claims that may be made against DISTRICT based upon any contention by any third party that an employer-employee relationship exists by reason of this Agreement.

- B. It is further understood and agreed by the parties hereto that CONTRACTOR in the performance of its obligation hereunder is subject to the control or direction of DISTRICT as to the designation of tasks to be performed, the results to be accomplished by the services hereunder agreed to be rendered and performed, and not the means, methods, or sequence used by CONTRACTOR for accomplishing the results.
- C. If, in the performance of this Agreement, any third persons are employed by CONTRACTOR, such person shall be entirely and exclusively under the direction, supervision, and control of CONTRACTOR. All terms of employment, including hours, wages, working conditions, discipline, hiring, and discharging, or any other terms of employment or requirements of law, shall be determined by CONTRACTOR, and the DISTRICT shall have no right or authority over such persons or the terms of such employment.
- D. It is further understood and agreed that as an independent contractor and not an employee of DISTRICT, neither the CONTRACTOR nor CONTRACTOR'S assigned personnel shall have any entitlement as a DISTRICT employee, right to act on behalf of DISTRICT in any capacity whatsoever as agent, nor to bind DISTRICT to any obligation whatsoever. CONTRACTOR shall not be covered by worker's compensation; nor shall CONTRACTOR be entitled to compensated sick leave, vacation leave, retirement entitlement, participation in group health, dental, life and other insurance programs, or entitled to other fringe benefits payable by the DISTRICT to employees of the DISTRICT.
- E. It is further understood and agreed that CONTRACTOR must issue W-2 and 941 Forms for income and employment tax purposes, for all of CONTRACTOR'S assigned personnel under the terms and conditions of this Agreement.

13. CONTRACTOR IDENTIFICATION

CONTRACTOR shall provide the DISTRICT with the following information for the purpose of compliance with California Unemployment Insurance Code section 1088.8 and Sacramento County Code Chapter 2.160: CONTRACTOR'S name, address, telephone number, social security number or federal tax identification number, and whether dependent health insurance coverage is available to CONTRACTOR.

14. COMPLIANCE WITH CHILD, FAMILY AND SPOUSAL SUPPORT REPORTING OBLIGATIONS

- A. CONTRACTOR's failure to comply with state and federal child, family and spousal support reporting requirements regarding CONTRACTOR's employees or failure to implement lawfully served wage and earnings assignment orders or notices of assignment relating to child, family and spousal support obligations shall constitute a default under this Agreement.
- B. CONTRACTOR's failure to cure such default within 90 days of notice by DISTRICT shall be grounds for termination of this Agreement.

15. BENEFITS WAIVER

If CONTRACTOR is unincorporated, CONTRACTOR acknowledges and agrees that CONTRACTOR is not entitled to receive the following benefits and/or compensation from DISTRICT: medical, dental, vision and retirement benefits, life and disability insurance, sick leave, bereavement leave, jury duty leave, parental leave, or any other similar benefits or compensation otherwise provided to permanent civil service employees pursuant to the County Charter, the County Code, the Civil Service Rule, the Sacramento County Employees' Retirement System and/or any and all memoranda of understanding between DISTRICT and its employee organizations. Should CONTRACTOR or any employee or agent of CONTRACTOR seek to obtain such benefits from DISTRICT, CONTRACTOR agrees to indemnify and hold harmless DISTRICT from any and all claims that may be made against DISTRICT for such benefits.

16. RETIREMENT BENEFITS/STATUS

CONTRACTOR acknowledges and agrees that DISTRICT has not made any representations regarding entitlement, eligibility for and/or right to receive ongoing Sacramento County Employee Retirement System (SCERS) retirement benefits during the term of this Agreement. By entering into this Agreement, CONTRACTOR assumes sole and exclusive responsibility for any consequences, impacts or action relating to such retirement benefits that is or will be occasioned as a result of the services provided by CONTRACTOR under this Agreement. CONTRACTOR waives any rights to proceed against DISTRICT should SCERS modify or terminate retirement benefits based on CONTRACTOR'S provision of services under this Agreement.

17. CONFLICT OF INTEREST

CONTRACTOR and CONTRACTOR'S officers and employees shall not have a financial interest, or acquire any financial interest, direct or indirect, in any business, property or source of income which could be financially affected by or otherwise conflict in any manner or degree with the performance of services required under this Agreement.

18. LOBBYING AND UNION ORGANIZATION ACTIVITIES

- A. CONTRACTOR shall comply with all certification and disclosure requirements prescribed by Section 319, Public Law 101-121 (31 U.S.C. § 1352) and any implementing regulations.
- B. If services under this Agreement are funded with state funds granted to DISTRICT, CONTRACTOR shall not utilize any such funds to assist, promote or deter union organization by employees performing work under this Agreement and shall comply with the provisions of Government Code Sections 16645 through 16649.

19. NONDISCRIMINATION IN EMPLOYMENT, SERVICES, BENEFITS AND FACILITIES

- A. CONTRACTOR agrees and assures DISTRICT that CONTRACTOR and any sub-CONTRACTORS shall comply with all applicable federal, state, and local Anti-discrimination laws, regulations, and ordinances and to not unlawfully discriminate, harass, or allow harassment against any employee, applicant for employment, employee or agent of DISTRICT, or recipient of services contemplated to be provided or provided under this Agreement, because of race, ancestry, marital status, color, religious creed, political belief, national origin, ethnic group identification, sex, sexual orientation, age (over 40), medical condition (including HIV and AIDS), or physical or mental disability. CONTRACTOR shall ensure that the evaluation and treatment of its employees and applicants for employment, the treatment of DISTRICT employees and agents, and recipients of services are free from such discrimination and harassment.
- B. CONTRACTOR represents that it is in compliance with and agrees that it will continue to comply with the Americans with Disabilities Act of 1990 (42 U.S.C. § 12101 et seq.), the Fair Employment and Housing Act (Government Code § 12900 et seq.), and regulations and guidelines issued pursuant thereto.
- C. CONTRACTOR agrees to compile data, maintain records, and submit reports to permit effective enforcement of all applicable anti-discrimination laws and this provision.
- D. CONTRACTOR shall include this nondiscrimination provision in all subcontracts related to this Agreement.

20. PERFORMANCE AND PAYMENT BONDS

The Contractor shall, before beginning said work, file two bonds with the DISTRICT, each made payable to the Carmichael Recreation and Park District. These bonds shall be issued by a surety company authorized to do business in the State of California, and shall be maintained during the entire life of the Agreement at the expense of the Contractor. One bond shall be in the amount of

one hundred percent (100%) of the Agreement and shall guarantee the faithful performance of the Agreement. The second bond shall be the payment bond required by California Civil Code Division 3, Part 4, Title 15, Chapter 7, and shall be in the amount of one hundred percent (100%) of the Agreement. Any alterations made in the specifications which are a part of this Agreement or in any provision of this Agreement shall not operate to release any surety from liability on any bond required hereunder and the consent to make such alterations is hereby given, and any surety on said bonds hereby waives the provisions of California Civil Code Sections 2819 and 2845.

21. INDEMNIFICATION

To the fullest extent permitted by law, Contractor shall indemnify, defend, and hold harmless the DISTRICT and the County of Sacramento, their governing Boards, officers, directors, officials, employees, and authorized volunteers and agents, (collectively "Indemnified Parties") from and against any and all claims, demands, actions, losses, liabilities, damages, and all expenses and costs incidental thereto (collectively "Claims") including cost of defense, settlement, arbitration, and reasonable attorneys' fees, resulting from injuries to or death of persons, including but not limited to employees of either Party hereto, and damage to or destruction of property or loss of use thereof, including but not limited to the property of either Party hereto, arising out of, pertaining to, or resulting from the acts or omissions of the Contractor, its officers, employees, or agents, or the acts or omissions of anyone else directly or indirectly acting on behalf of the Contractor, or for which the Contractor is legally liable under law regardless of whether caused in part by an Indemnified Party. Contractor shall not be liable for any Claims to the extent caused by the active negligence of an Indemnified Party where such indemnification would be invalid under Subdivision (b) of Section 2782 of the Civil Code.

This indemnity obligation shall not be limited by the types and amounts of insurance or self-insurance maintained by CONTRACTOR or CONTRACTOR'S subcontractors or subcontractors at any tier.

Nothing in this Indemnity obligation shall be construed to create any duty to, any standard of care with reference to, or any liability or obligation, contractual or otherwise, to any third party.

The provisions of this Indemnity obligation shall survive the expiration or termination of the Agreement.

22. INSURANCE

Without limiting CONTRACTOR'S indemnification, CONTRACTOR shall maintain in force at all times during the term of this Agreement and any extensions or modifications thereto, insurance as specified in Exhibit B. It is the responsibility of CONTRACTOR to notify its insurance advisor or insurance carrier(s) regarding

coverage, limits, forms, and other insurance requirements specified in Exhibit B. It is understood and agreed that DISTRICT shall not pay any sum to CONTRACTOR under this Agreement unless and until DISTRICT is satisfied that all insurance required by this Agreement is in force at the time services hereunder are rendered. Failure to maintain insurance as required in this agreement may be grounds for material breach of contract.

23. COMPENSATION AND PAYMENT OF INVOICES LIMITATIONS

- A. Compensation under this Agreement shall be limited to the Maximum Total Payment Amount set forth in Exhibit C, or Exhibit C as modified by DISTRICT in accordance with express provisions in this Agreement.
- B. CONTRACTOR shall submit an invoice in accordance with the procedures prescribed by DISTRICT on a monthly basis for services performed during the previous month. Invoices shall be submitted to DISTRICT no later than the fifteenth (15th) day following the invoice period, and DISTRICT shall pay CONTRACTOR within thirty (30) days after receipt of an appropriate and correct invoice.
- C. DISTRICT operates on a July through June fiscal year. Invoices for services provided in any fiscal year must be submitted no later than July 31, one month after the end of the fiscal year. Invoices submitted after July 31 for the prior fiscal year shall not be honored by DISTRICT unless CONTRACTOR has obtained prior written DISTRICT approval to the contrary.
- D. CONTRACTOR shall maintain for four years following termination of this agreement full and complete documentation of all services and expenditures associated with performing the services covered under this Agreement. Expense documentation shall include: time sheets or payroll records for each employee; receipts for supplies; applicable subcontract expenditures; applicable overhead and indirect expenditures.
- E. In the event CONTRACTOR fails to comply with any provisions of this Agreement, DISTRICT may withhold payment until such non-compliance has been corrected.

24. SUBCONTRACTS, ASSIGNMENT

- A. CONTRACTOR shall obtain prior written approval from DISTRICT before subcontracting any of the services delivered under this Agreement. CONTRACTOR remains legally responsible for the performance of all contract terms including work performed by third parties under subcontracts. Any subcontracting will be subject to all applicable provisions of this Agreement. CONTRACTOR shall be held responsible

by DISTRICT for the performance of any subcontractor whether approved by DISTRICT or not.

- B. This Agreement is not assignable by CONTRACTOR in whole or in part, without the prior written consent of DISTRICT.

25. AMENDMENT AND WAIVER

Except as provided herein, no alteration, amendment, variation, or waiver of the terms of this Agreement shall be valid unless made in writing and signed by both parties. Waiver by either party of any default, breach or condition precedent shall not be construed as a waiver of any other default, breach, or condition precedent, or any other right hereunder. No interpretation of any provision of this Agreement shall be binding upon DISTRICT unless agreed in writing by DISTRICT'S Administrator and counsel for DISTRICT.

26. SUCCESSORS

This Agreement shall bind the successors of DISTRICT and CONTRACTOR in the same manner as if they were expressly named.

27. TIME

Time is of the essence of this Agreement.

28. INTERPRETATION

This Agreement shall be deemed to have been prepared equally by both of the parties, and the Agreement and its individual provisions shall not be construed or interpreted more favorably for one party on the basis that the other party prepared it.

29. DISPUTES

In the event of any dispute arising out of or relating to this Agreement, the parties shall attempt, in good faith, to promptly resolve the dispute mutually between themselves. Pending resolution of any such dispute, CONTRACTOR shall continue without delay to carry out all its responsibilities under this Agreement unless the Agreement is otherwise terminated in accordance with the Termination provisions herein. DISTRICT shall not be required to make payments for any services that are the subject of this dispute resolution process until such dispute has been mutually resolved by the parties. If the dispute cannot be resolved within 15 calendar days of initiating such negotiations or such other time period as may be mutually agreed to by the parties in writing, either party may pursue its available legal and equitable remedies, pursuant to the laws of the State of California. Nothing in this Agreement or provision shall constitute a waiver of any of the government claim filing requirements set forth in Title 1, Division 3.6, of the California Government Code or as otherwise set forth in local, state, and federal law.

30. TERMINATION

- A. DISTRICT may terminate this Agreement without cause upon thirty (30) days written notice to the other party. Notice shall be deemed served on the date of mailing. If notice of termination for cause is given by DISTRICT to CONTRACTOR and it is later determined that CONTRACTOR was not in default or the default was excusable, then the notice of termination shall be deemed to have been given without cause pursuant to this paragraph (A).
- B. DISTRICT may terminate this Agreement for cause immediately upon giving written notice to CONTRACTOR should CONTRACTOR materially fail to perform any of the covenants contained in this Agreement in the time and/or manner specified. In the event of such termination, DISTRICT may proceed with the work in any manner deemed proper by DISTRICT. If notice of termination for cause is given by DISTRICT to CONTRACTOR and it is later determined that CONTRACTOR was not in default or the default was excusable, then the notice of termination shall be deemed to have been given without cause pursuant to paragraph (A) above.
- C. DISTRICT may terminate or amend this Agreement immediately upon giving written notice to CONTRACTOR, 1) if advised that funds are not available from external sources for this Agreement or any portion thereof, including if distribution of such funds to the DISTRICT is suspended or delayed; 2) if funds for the services and/or programs provided pursuant to this Agreement are not appropriated by the State; 3) if funds in DISTRICT's yearly proposed and/or final budget are not appropriated by DISTRICT for this Agreement or any portion thereof; or 4) if funds that were previously appropriated for this Agreement are reduced, eliminated, and/or re-allocated by DISTRICT as a result of mid-year budget reductions.
- D. If this Agreement is terminated by DISTRICT under paragraph (A) or (C) above:
 - 1. CONTRACTOR shall cease rendering services pursuant to this Agreement as of the termination date.
 - 2. CONTRACTOR shall deliver to DISTRICT copies of all writings prepared pursuant to this Agreement. The term "writings" shall be construed to mean and include: handwriting, typewriting, drawings, blueprints, printing, electronic media, photostating, photographing, and every other means of recording upon any tangible thing, any form of communication or representation, including letters, words, pictures, sounds, or symbols, or combinations thereof.

3. CONTRACTOR shall not incur any expenses under this Agreement after notice of termination and shall cancel any outstanding expenses obligations to a third party that CONTRACTOR can legally cancel.
- E. If this Agreement is terminated under paragraphs (A) or (C), above, CONTRACTOR shall be paid for authorized and approved services performed prior to the termination date in accordance with the provisions of the Compensation and Payment of Invoices Limitations provision of this Agreement.
- F. The DISTRICT'S Administrator has authority to terminate this Agreement under paragraphs (A), (B), or (C), above.

31. REPORTS

CONTRACTOR shall, without additional compensation, therefore, make fiscal, program evaluation, progress, and such other reports as may be reasonably required by DISTRICT'S Administrator concerning CONTRACTOR'S activities as they affect the contract duties and purposes herein. DISTRICT shall explain procedures for reporting the required information.

32. AUDITS AND RECORDS

Upon DISTRICT'S request, DISTRICT or its designee shall have the right at reasonable times and intervals to audit, at CONTRACTOR'S premises, CONTRACTOR'S financial and program records as DISTRICT deems necessary to determine CONTRACTOR'S compliance with legal and contractual requirements and the correctness of claims submitted by CONTRACTOR. CONTRACTOR shall maintain such records for a period of four years following termination of the Agreement and shall make them available for copying upon DISTRICT'S request at DISTRICT'S expense. DISTRICT shall have the right to withhold any payment under this Agreement until CONTRACTOR has provided access to CONTRACTOR'S financial and program records related to this Agreement.

33. PRIOR AGREEMENTS

This Agreement constitutes the entire contract between DISTRICT and CONTRACTOR regarding the subject matter of this Agreement. Any prior agreements, whether oral or written, between DISTRICT and CONTRACTOR regarding the subject matter of this Agreement are hereby terminated effective immediately upon full execution of this Agreement.

34. SEVERABILITY

If any term or condition of this Agreement or the application thereof to any person(s) or circumstance is held invalid or unenforceable, such invalidity or unenforceability shall not affect other terms, conditions, or applications which can

be given effect without the invalid term, condition, or application; to this end the terms and conditions of this Agreement are declared severable.

35. FORCE MAJEURE

Neither CONTRACTOR nor DISTRICT shall be liable or responsible for delays or failures in performance resulting from events beyond the reasonable control of such party and without fault or negligence of such party. Such events shall include but not be limited to acts of God, strikes, lockouts, riots, acts of war, epidemics, acts of government, fire, power failures, nuclear accidents, earthquakes, unusually severe weather, acts of terrorism, or other disasters, whether or not similar to the foregoing, and acts or omissions or failure to cooperate of the other party or third parties (except as otherwise specifically provided herein).

36. SURVIVAL OF TERMS

All services performed and deliverables provided pursuant to this Agreement are subject to all of the terms, conditions, price discounts and rates set forth herein, notwithstanding the expiration of the initial term of this Agreement or any extension thereof. Further, the terms, conditions and warranties contained in this Agreement that by their sense and context are intended to survive the completion of the performance, cancellation or termination of this Agreement shall so survive.

37. AUTHORITY TO EXECUTE

Each person executing this Agreement represents and warrants that he or she is duly authorized and has legal authority to execute and deliver this Agreement for or on behalf of the parties to this Agreement. Each party represents and warrants to the other that the execution and delivery of the Agreement and the performance of such party's obligations hereunder have been duly authorized.

38. DUPLICATE COUNTERPARTS

This Agreement may be executed in duplicate counterparts. The Agreement shall be deemed executed when it has been signed by both parties.

Signatures scanned and transmitted electronically shall be deemed original signatures for purposes of this Agreement, with such scanned signatures having the same legal effect as original signatures. This Agreement may be executed through the use of an electronic signature and will be binding on each party as if it were physically executed.

[THE REMAINDER OF THIS PAGE INTENTIONALLY LEFT BLANK]

IN WITNESS WHEREOF, the parties hereto have caused this Agreement to be duly executed as of the day and year first written above.

“DISTRICT”

“CONTRACTOR”

**Carmichael Recreation & Park District,
a park district existing under authority
and of Public Resources Code
§ 5780 et seq.**

**COMPANY NAME
TYPE**

By: _____
Mike Blondino, District Administrator

By: _____
Authorized Signer Name
Title

Date: _____

Date: _____

CONTRACT REVIEWED AND APPROVED as to form
BY COUNTY COUNSEL

Name Robert P. Parrish, Deputy County Counsel
Date: April 26, 2023

[THE REMAINDER OF THIS PAGE INTENTIONALLY LEFT BLANK]

EXHIBIT A to Agreement

SCOPE OF SERVICES

1. SERVICE LOCATION(S)

Facility Name(s):

Street Address:

City and Zip Code:

2. SCOPE

A. Contractor will furnish all labor, materials, services, transportation, mechanical workmanship, required for CONTRACT NO. 23-, as provided for and set forth in said plans and specifications, or in either of them, which said plans and specifications are hereby referred to and by such reference incorporated herein and made a part of this Agreement.

B. The DISTRICT'S Administrator or designee, may negotiate with CONTRACTOR and approve reasonable modifications in tasks, work products, schedules, milestones, and staff assignments so long as such modifications are within the general scope of services provided under this Agreement, do not exceed the Maximum Total Payment Amount, and are determined to be in the best interest of DISTRICT.

3. SCHEDULE

CONTRACTOR shall perform the services in an expeditious manner in accordance with a mutually acceptable schedule developed between DISTRICT and CONTRACTOR.

4. RESPONSIBILITIES OF DISTRICT AND CONTRACTOR FOR SCOPE

A. All of the said work done under this Agreement shall be under the supervision of and performed to the satisfaction of the Sacramento County Engineer, The Landscape Architect or the Park District Project Manager, who shall have the right to reject any and all materials and supplies furnished by the CONTRACTOR which do not comply with said plans and specifications, together with the right to require the Contractor to replace any and all work furnished by the Contractor which is not, either in workmanship or material, in strict accordance with said plans and specifications.

B. CONTRACTOR shall be solely responsible for the quality and accuracy of its work and the work of its subcontractors performed in connection with

this Agreement. Any review, approval, or concurrence therewith by the DISTRICT shall not be deemed to constitute acceptance or waiver by the DISTRICT of any error or omission as to such work. CONTRACTOR shall coordinate the activities of any subcontractors.

5. AUTHORITY OF CONTRACTOR PERFORMING SCOPE OF WORK

CONTRACTOR is retained to provide and perform the scope of services covered by this Agreement. CONTRACTOR, including CONTRACTOR’S assigned personnel, shall have no authority to represent DISTRICT or DISTRICT staff at any meetings of public or private agencies unless an appropriate DISTRICT official provides prior written authorization for such representation which outlines the purpose, scope and duration of such representation. CONTRACTOR shall possess no authority or right to act on behalf of DISTRICT in any capacity whatsoever as agent, nor to bind DISTRICT to any obligations whatsoever. DISTRICT is responsible for making all policy and governmental decisions related to the work covered by this Agreement.

6. PUBLICATION OF DOCUMENTS AND DATA

CONTRACTOR shall not publish, or disclose to any third party, documents, data, or any confidential information relative to the work of the DISTRICT without the prior written consent of DISTRICT, however, submission or distribution to meet official regulatory requirements, or for other purposes authorized by this Agreement, shall not be construed as publication in derogation of the rights of either the DISTRICT or CONTRACTOR.

7. PROJECT PERSONNEL

DISTRICT: NAME James Perry
 PHONE (916) 416-3765
 FAX (916) 485-0805
 EMAIL jperry@carmichaelpark.com

 NAME Mike Blondino
 PHONE (916) 485-5322
 FAX (916) 485-0805
 EMAIL mblondino@carmichaelpark.com

CONTRACTOR: NAME
 PHONE
 FAX
 EMAIL

[THE REMAINDER OF THIS PAGE INTENTIONALLY LEFT BLANK]

EXHIBIT B to Agreement

CARMICHAEL RECREATION AND PARK DISTRICT INSURANCE REQUIREMENTS

Without limiting CONTRACTOR'S indemnification, CONTRACTOR shall procure and maintain for the duration of the Agreement, insurance against claims for injuries to persons or damages to property which may arise from or in connection with the performance of the Agreement by CONTRACTOR, its agents, representatives or employees. DISTRICT shall retain the right at any time to review the coverage, form, and amount of the insurance required hereby. If in the opinion of DISTRICT Risk Manager, insurance provisions in these requirements do not provide adequate protection for DISTRICT and for members of the public, DISTRICT may require CONTRACTOR to obtain insurance sufficient in coverage, form and amount to provide adequate protection. DISTRICT'S requirements shall be reasonable but shall be imposed to assure protection from and against the kind and extent of risks that exist at the time a change in insurance is required.

1. Verification of Coverage

CONTRACTOR shall furnish DISTRICT with certificates evidencing coverage required below. **Copies of required endorsements must be attached to the certificates provided.** DISTRICT Risk Manager may approve self-insurance programs in lieu of required policies of insurance if, in the opinion of the Risk Manager, the interests of DISTRICT and general public are adequately protected. All certificates, evidences of self-insurance, and additional insured endorsements are to be received and approved by DISTRICT before performance commences. DISTRICT reserves the right to require that CONTRACTOR provide complete copies of any policy of insurance including endorsements offered in compliance with these specifications.

2. Minimum Scope of Insurance

Coverage shall be at least as broad as:

GENERAL LIABILITY: Insurance Services Office's Commercial General Liability occurrence coverage form CG 0001. Including, but not limited to Premises/Operations, Products/Completed Operations, Contractual, and Personal & Advertising Injury, without additional exclusions or limitations, unless approved by DISTRICT Risk Manager.

AUTOMOBILE LIABILITY: Insurance Services Office's Commercial Automobile Liability coverage form CA 00 01. Commercial Automobile Liability: auto coverage symbol "1" (any auto) for corporate/business owned vehicles. If there are no owned or leased vehicles, symbols 8 and 9 for non-owned and hired autos shall apply. Personal Lines automobile insurance shall apply if vehicles are individually owned.

WORKERS' COMPENSATION: Statutory requirements of the State of California and Employer's Liability Insurance.

UMBRELLA or Excess Liability policies are acceptable where the need for higher liability limits is noted in the Minimum Limits of Insurance and shall provide liability coverages that at least follow form over the underlying insurance requirements where necessary for Commercial General Liability, Commercial Automobile Liability, Employers' Liability, and any other liability coverage (other than Professional Liability) designated under the Minimum Scope of Insurance.

3. Minimum Limits of Insurance

CONTRACTOR shall maintain limits no less than:

General Liability shall be on an Occurrence basis (as opposed to Claims Made basis). Minimum limits and structure shall be:

General Aggregate:	\$2,000,000
Products Comp/Op Aggregate:	\$2,000,000
Personal & Adv. Injury:	\$1,000,000
Each Occurrence:	\$2,000,000

Automobile Liability:

- a. Commercial Automobile Liability for Corporate/business owned vehicles including non-owned and hired, \$1,000,000 Combined Single Limit.
- b. Personal Lines Automobile Liability for Individually owned vehicles, \$250,000 per person, \$500,000 each accident, \$100,000 property damage.

Workers' Compensation: Statutory.

Employer's Liability: \$1,000,000 per accident for bodily injury or disease.

4. Deductibles and Self-Insured Retention

Any deductible or self-insured retention that apply to any insurance required by this Agreement must be declared and approved by DISTRICT.

5. Other Insurance Provisions

The insurance policies required in this Agreement are to contain, or be endorsed to contain, as applicable, the following provisions:

6. All Policies:

- a. ACCEPTABILITY OF INSURERS: Insurance is to be placed with insurers with a current A.M. Best's rating of no less than A-: VII. DISTRICT Risk Manager may waive or alter this requirement, or accept self-insurance in lieu

of any required policy of insurance if, in the opinion of the Risk Manager, the interests of DISTRICT and the general public are adequately protected.

- b. MAINTENANCE OF INSURANCE COVERAGE: CONTRACTOR shall maintain all insurance coverages and limits in place at all times and provide DISTRICT with evidence of each policy's renewal within ten (10) days after its anniversary date.

CONTRACTOR is required by this Agreement to immediately notify DISTRICT if they receive a communication from their insurance carrier or agent that any required insurance is to be canceled, non-renewed, reduced in scope or limits or otherwise materially changed. CONTRACTOR shall provide evidence that such cancelled or non-renewed or otherwise materially changed insurance has been replaced or its cancellation notice withdrawn without any interruption in coverage, scope or limits. Failure to maintain required insurance in force shall be considered a material breach of the Agreement.

7. Commercial General Liability and/or Commercial Automobile Liability:

- a. ADDITIONAL INSURED STATUS: DISTRICT and the County of Sacramento, and their governing Boards, officers, directors, officials, employees, and authorized volunteers and agents (each an "Additional Insured Party," and collectively "Additional Insured Parties"), are to be endorsed as additional insureds as respects: liability arising out of activities performed by or on behalf of CONTRACTOR; products and completed operations of CONTRACTOR; premises owned, occupied or used by CONTRACTOR; or automobiles owned, leased, hired or borrowed by CONTRACTOR. The coverage shall contain no endorsed limitations on the scope of protection afforded to the Additional Insured Parties
- b. PRIMARY INSURANCE: For any claims related to this agreement, CONTRACTOR'S insurance coverage shall be endorsed to be primary insurance as respects any insurance or self-insurance maintained by the Additional Insured Parties. Any insurance or self-insurance maintained by the Additional Insured Parties shall be excess of CONTRACTOR'S insurance and shall not contribute with it.
- c. SEVERABILITY OF INTEREST: CONTRACTOR'S insurance shall apply separately to each insured against whom claim is made or suit is brought, except with respect to the limits of the insurer's liability.
- d. SUBCONTRACTORS: CONTRACTOR shall be responsible for the acts and omissions of all its subcontractors and additional insured endorsements as provided by CONTRACTOR'S subcontractor.

8. Workers' Compensation:

WORKERS' COMPENSATION WAIVER OF SUBROGATION: The workers' compensation policy required hereunder shall be endorsed to state that the workers' compensation carrier waives its right of subrogation against the DISTRICT and the County of Sacramento, and their governing Boards, officers, directors, officials, employees, and authorized volunteers and agents which might arise by reason of payment under such policy in connection with performance under this Agreement by CONTRACTOR. Should CONTRACTOR be self-insured for workers' compensation, CONTRACTOR hereby agrees to waive its right of subrogation against the DISTRICT and the County of Sacramento, and their governing Boards, officers, directors, officials, employees, and authorized volunteers and agents .

9. Property omitted.

10. Notification of Claim

If any claim for damages is filed with CONTRACTOR or if any lawsuit is instituted against CONTRACTOR, that arise out of or are in any way connected with CONTRACTOR'S performance under this Agreement and that in any way, directly or indirectly, contingently or otherwise, affect or might reasonably affect DISTRICT, CONTRACTOR shall give prompt and timely notice thereof to DISTRICT. Notice shall be prompt and timely if given within thirty (30) days following the date of receipt of a claim or ten (10) days following the date of service of process of a lawsuit.

[THE REMAINDER OF THIS PAGE INTENTIONALLY LEFT BLANK]

EXHIBIT C to Agreement

COMPENSATION

1. MAXIMUM PAYMENT TO CONTRACTOR

The Maximum Total Payment Amount under this Agreement is: \$ _____

2. COMPENSATION COMPONENTS

Includes the labor, materials and supplies to perform contracted services.

3. ITEMIZED TASKS AND SUBTASKS

If CONTRACTOR'S Proposal contains a schedule of tasks or subtasks with identified levels of effort such as estimated hours and/or estimated costs, or identifiable work products, milestones, or other events, then compensation for these individual tasks or activities shall not exceed the identified estimate or other limiting factors without the written approval of DISTRICT'S Project Manager. CONTRACTOR shall promptly notify DISTRICT'S Project Manager in writing of any tasks, subtasks, work products, or milestones that need to be reevaluated and indicate the reason and/or justification for such reevaluation. DISTRICT'S Project Manager is authorized to negotiate adjustments of individual tasks so long as the work is within the general scope of the project and the total compensation does not exceed the Maximum Total Payment Amount under this Agreement listed above.

4. WORK NOT IN SCOPE OF SERVICES

CONTRACTOR shall immediately notify the DISTRICT'S Project Manager in writing of any work that the DISTRICT requests to be performed that CONTRACTOR believes is outside of the original scope of work covered by this Agreement. If it is determined that said request is outside of the scope of work, such work shall not be performed unless and until the DISTRICT'S Administrator approves such request in writing and authorizes the use of any contingency funds for such work, or an amendment providing for an adjustment in CONTRACTOR'S compensation is approved and executed by both parties.

5. SUBMISSION OF INVOICES

CONTRACTOR shall address and submit all invoices associated with this Agreement by U.S. mail or personal delivery to the following address:

Carmichael Recreation and Park District
5750 Grant Avenue
Carmichael, CA 95608
Attn: Accounts Payable

CONTRACTOR shall include the following information on all invoices:

Project Name:

Date of Invoice Submission

Time Period Invoice Covers

Services Provided and Respective Compensation Requested

Any other information deemed necessary by CONTRACTOR and/or DISTRICT.

DISTRICT may change the address to which subsequent invoices shall be sent by giving written notice designating a change of address to CONTRACTOR, which shall be effective upon receipt.

6. PAYMENTS

In accordance with the Compensation and Payment of Invoices Limitations provision of this Agreement, DISTRICT shall address and submit payments to CONTRACTOR at address in the Notice provision of this Agreement.

CONTRACTOR may change the address to which subsequent payments shall be sent by giving written notice designating a change of address to DISTRICT, which shall be effective upon receipt.

[THE REMAINDER OF THIS PAGE INTENTIONALLY LEFT BLANK]

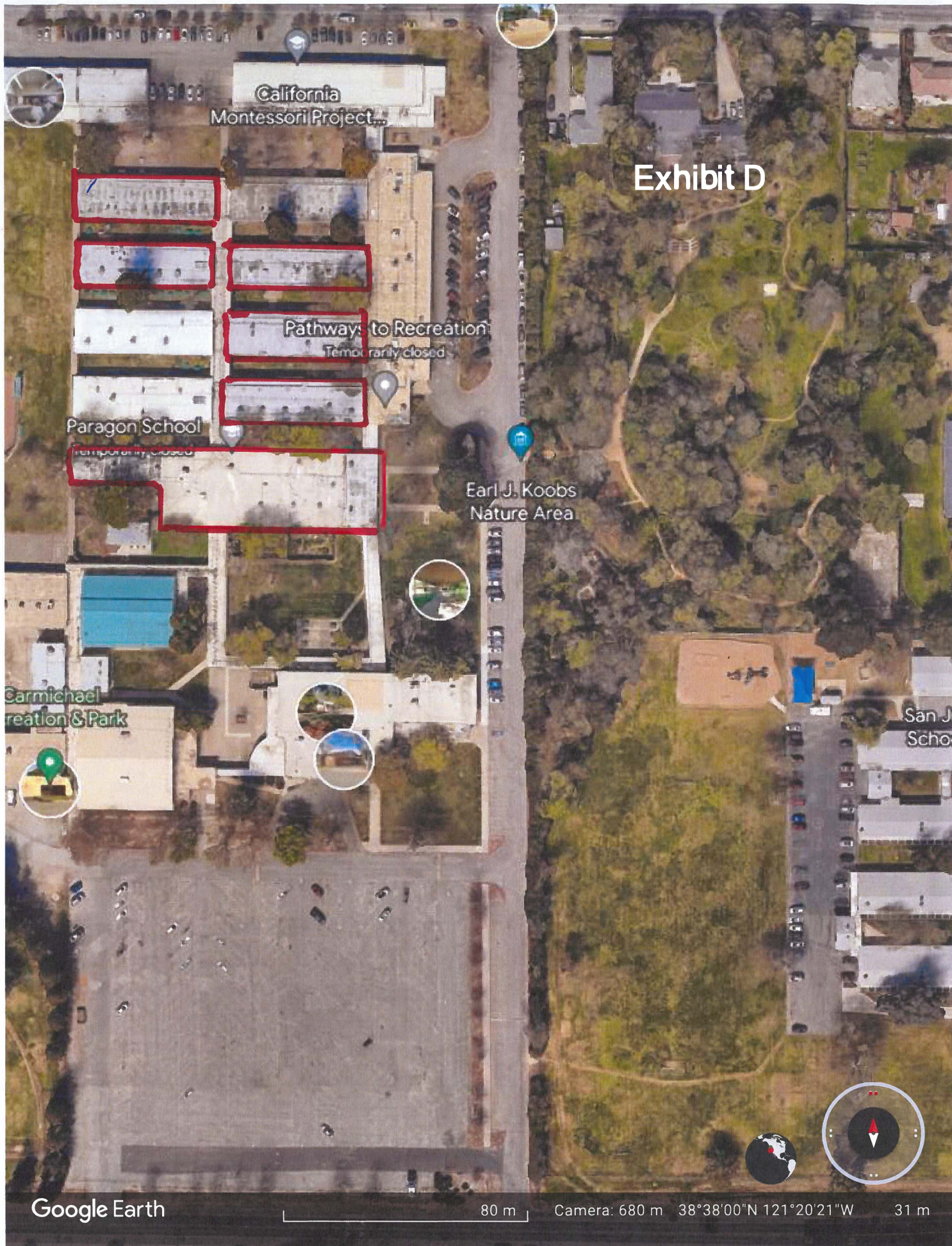

Exhibit D



Carlisle Roof Foam and Coatings Restoration Coatings

Table of Contents

October 2019

	Page
Part I – General	
1.01 Description.....	03
1.02 Applicability.....	03
1.03 Quality Assurance.....	03
1.04 Restrictions and Exclusions.....	04
1.05 Submittals.....	05
1.06 Warranty.....	05
1.07 Job Conditions.....	06
1.08 Product Delivery, Storage and Handling.....	06
Part II - Products	
2.01 General.....	07
2.02 Coatings.....	07
2.03 Primers.....	09
2.04 Other CRFC Products.....	13
2.05 Equipment.....	14
2.06 Granules.....	15
2.07 Other Related Products.....	15
Part III – Execution	
3.01 General.....	15
3.02 Surface Inspection.....	16
3.03 Substrate Preparation.....	16
3.04 Surface Repair & Detail Work.....	17
3.05 Coating Application.....	17
3.06 Clean Up.....	18
3.07 Roof Walkways.....	18
Attachment I – Assessment and Investigation.....	20
Attachment II – Specification Substrate Preparations – Asphaltic Roofing.....	23
Attachment III – Specification Substrate Preparations – Metal Roofing.....	27
Attachment IV – Specification Substrate Preparations – SPF.....	30
Attachment V – Specification Substrate Preparations – Single Ply Membranes (EPDM, TPO and PVC).....	33
Application Details.....	37

Note: In addition to information listed in this section Specifiers and Authorized applicators should reference Spec Supplement and Design Reference Sections for other pertinent information.

Carlisle Roof Foam and Coatings Restoration Coatings

October 2019

This Specification section and associated attachments represent Carlisle Roof Foam and Coatings (CRFC) requirement for restoration of various existing roofing systems with the CRFC coatings and accessories.

A thorough investigation of the existing roof must be performed by a qualified representative of the building owner. The investigation is to assess the condition of the roof and to determine any needed repairs prior to commencing the restoration work. The CRFC Authorized applicator shall assess the condition of the roof surface to determine the level of preparation and repairs needed. The contractor shall also perform various peel/adhesion testing to determine whether the use of primers will be required.

PART I GENERAL

1.01 Description

This restoration system utilizes the application of CRFC SeamlesSEAL™ ULTRA Silicone or SeamlesSEAL Acrylic coatings after thoroughly preparing the existing roof surface to receive the new coating. An initial assessment is performed by the Authorized Applicator to evaluate the condition of the roof surface and perform adhesion tests to determine the cleaning and priming requirements. After preparation of the existing roof surface, the coating is applied to achieve the desired dry film thickness and CRFC warranty requirements. Refer to the table in the warranty 1.06 for the total minimum dry film thickness and the warranty duration.

1.02 Applicability

- A. The restoration coating is intended to enhance and extend the service life of an existing sound and watertight roof or those that may experience occasional minor leaks. The system is not suitable for the restoration of roofs which have exceeded or are approaching the end of their service life and require substantial repair.
- B. The assessment and examination of the existing roof surface to be restored shall be performed by the CRFC authorized roofing applicator and/or CRFC technical representative. The assessment and examinations shall focus on the condition of the roof, surface preparation required and the components to be restored.
- C. When in-depth investigation is needed to assess the entire existing roof system, a roof consultant or qualified representative shall be obtained by the building owner to conduct such investigation. The investigation will identify all necessary system repairs prior to commencing restoration work.

1.03 Quality Assurance

- A. Moisture surveys are strongly recommended, when moisture entrapment is suspected, on roofs installed over vapor barriers, or existing membranes that may have experienced a leak.

- B. Initial sampling and core cuts may be collected by the CRFC Authorized Applicator for moisture analysis. Detailed moisture surveys may be conducted by a qualified third-party using IR scans, nuclear scans or by taking core cuts.
- C. For adhesion and core cut tests there is a minimum of 3 adhesion/cut test areas that are required per 10,000 sq. ft. area with additional adhesion/cut test area recommended for every additional 10,000 sq. ft. of roofing.
- D. During the initial roof inspection by the CRFC Authorized Applicator, adhesion tests are required to assess the adhesion of the coating and to determine the extent of preparation work needed for the surface. The adhesion test is performed after the surface is entirely cleaned. A minimum value of 2 (pounds per linear inch) should be the target otherwise additional cleaning and priming may be required. Consult with CRFC representative for additional recommendations
- E. When inspecting an existing gravel built-up roof surface, a small sample (1/2-1") of the asphaltic surface shall be immersed in a clear glass bottle containing Isopropyl alcohol. After shaking vigorously, the liquid in the bottle should be observed for any discoloration.
 - 1. If discoloration is detected, then the sample is asphalt.
 - 2. If the liquid remains clear it indicates that the sample is coal tar.

Note: The coating restoration system is not intended for use on coal tar pitch roofs.

- F. When applying the coating restoration system over asphaltic roofs, modified bitumen, a cap sheet or metal roofs with rust, the use of Prime-Tek Bleed Block primer is strongly recommended even if an adhesion test yields acceptable values.
 - 1. For asphaltic roofs, Prime-Tek Bleed Block primer will help prevent bleed through and the possible staining of the new coating.
 - 2. For metal roofs, Prime-Tek Bleed Block primer will inhibit future rust formation.

1.04 Restrictions and Exclusions

- A. This restoration coating system is not suitable over roofs with severely ponded conditions or those which are nearing the end of their service life and require substantial repairs.
- B. Do not apply this restoration system on roofs which have become severely crazed and brittle. Widespread cracks, punctures, blistering, and tears scattered through the roof are deemed unacceptable and the roof shall not be restored using this system.
- C. Metal roofs with severe rust or panel deflections are not restorable. The severely rusted/deflective panels must be removed and replaced. Small areas of surface rust can be treated as outlined in the Attachment III "Substrate Preparations – Metal Roofing".
- D. Roofs which have sustained severe wind or hail damage cannot be restored unless thoroughly investigated by a qualified consultant, hired by the building owner, and the roofs have been repaired and returned to serviceable condition.

- E. Existing roofs with moisture entrapment or large delaminated areas must be investigated by a qualified roof consultant and the roof returned to a serviceable condition.
- F. Ballasted roof systems are generally not suitable for restoration coating systems

1.05 Submittals

- A. When a CRFC restoration system warranty is considered, the Authorized Applicator shall contact CRFC representative for a project evaluation and submit to Carlisle Roof Foam and Coatings a completely executed “request for roofing warranty” along with:
 - 1. Project specification
 - 2. Preinstallation pictures
 - 3. Detailed roof drawing including roof penetrations, curbs, perimeter details, drains, and saddles or crickets if applicable.
 - 4. Peel adhesion test results
- B. A completely executed “notice of completion” must be submitted to CRFC to schedule the necessary inspection. The restoration work must be inspected and accepted by a CRFC Field Service Representative prior to issuance of the Carlisle Roof Foam and Coatings warranty, as outlined in Paragraph 1.06 “Warranty”.
- C. When a non CRFC Authorized Applicator is selected by the building owner to perform coating restoration using CRFC products and accessories, such applicator must submit to Carlisle, building owner and their representative, the following documents at or before time of bid:
 - 1. Reference projects with contacts
 - 2. Years of experience
 - 3. Volume of restoration work completed 5 years prior to the date.
 - 4. Application to become a CRFC Authorized Applicator
- D. A sample of the CRFC Restoration Coating warranty should be made available for review by the building owner.

1.06 Warranty

- A. A restoration system warranty that covers labor and material is available for the CRFC restoration coating system for projects on commercial buildings and applies only to **products manufactured or marketed by CRFC**. Subject to the terms, conditions and limitations listed on the warranty form, CRFC will be responsible for leak repairs resulting from material and/or workmanship deficiency, for the duration of the warranty period.
- B. The duration of the restoration system warranty may be 10, 15 or 20 years of coverage, depending on

the dry mil thickness of the coating.

Warranty Duration	Minimum Dry Film Mil Thickness	
	Silicone Coatings	Acrylic Coatings
10 Year	20 mils	25 mils
15 Year	25 mils	30 mils
20 Year	30 mils	40 mils

Note: Contact CRFC for other available coatings

C. Access for Warranty Service

It shall be the owner’s responsibility to expose the roof system in the event that warranty service is required when access is impaired. Such impairment includes, but is not limited to:

1. Design features, such as window washing systems, which require the installation of traffic surface units in excess of 80 pounds per unit.
2. Any equipment, ornamentation, building service units and other top surfacing materials which are not defined as part of this specification.
3. Photovoltaic and Mounting Systems or other Rooftop equipment that do not provide CRFC with reasonable access to the roofing system for the purposes of warranty investigation and related repairs.

CAUTION: Applications such as walking decks, terraces, patios or areas subjected to conditions not typically found on roofing systems are **not** eligible for warranties.

- D. The formation or presence of mold or fungi in a building is dependent upon a broad range of factors including, but not limited to, the presence of spores and nutrient sources, moisture, temperatures, climatic conditions, relative humidity, and heating/ventilating systems and their maintenance and operating capabilities. These factors are beyond the control of CRFC and CRFC shall not be responsible for any claims, repairs, restoration or damages relating to the presence of any irritants, contaminants, vapors, fumes, molds, fungi, bacteria, spores, mycotoxins, or the like in any building or in the air, land, or water serving the building.

1.07 Job Conditions

- A. Prior to application of the coating, the applicable PDS shall be referenced to identified surface temperature limitations based on coating system to be utilized. The service temperature of any surface to be coated shall not exceed 180°F (82°C).
- B. Moisture in the form of rain, fog, frost, dew may adversely affect the coating and adhesion. Do not apply coating when these conditions exist.
- C. To prevent surface contamination from coating overspray, mask areas where coating is to be terminated. With owner permission, seal/close ventilation intakes and protect surrounding equipment from potential overspray.
- D. Compatibility to chemical exposure will depend on type of coating used. CRFC should be contacted for verification of compatibility with chemicals or specific waste products that may come in contact with the roofing system.

Caution: Surface moisture and icy conditions are not easily detected on lighter color membranes (white, tan, gray, etc.) especially those located in cold regions. The roof surface may become extremely slippery and care shall be exercised when accessing the roof in the early morning hours (dew formation), anytime after rain or during the winter. The use of sunglasses is strongly recommended when reflective coatings are used as the final coat.

1.08 Product Delivery, Storage and Handling

- A. Deliver materials to the site in their original, tightly sealed containers, all clearly labeled with manufacturer’s name, product identification and lot number.
- B. Safely store materials in their original containers out of the weather, keep dry and within the temperature limits specified by the manufacturer. Refer to specific product PDS for storage requirements.
- C. All materials shall be stored in compliance with applicable fire and safety requirements.
- D. Protect materials from damage during transit, handling, storage and application.
- E. If loading materials onto the roof, the CRFC Authorized Roofing Applicator must comply with the requirements of the specifier/owner to prevent overloading and possible disturbance to the building structure.

PART II PRODUCTS

2.01 General

The product components of this Carlisle Roof Foam and Coating (CRFC) Restoration Coating System are composed of CRFC products or those accepted by CRFC as compatible with this roofing system. The installation, performance or integrity of products by others, **when selected by the specifier and accepted as compatible**, is not the responsibility of CRFC and is expressly disclaimed by the CRFC Warranty.

2.02 Coatings

Table 1

Available Coating			
SeamlesSEAL™ ULTRA Silicone		SeamlesSEAL Acrylic	
Acronym		Acronym	
LS	Low Solids	QS	Quick Set
HS	High Solids	HT	High Tensile
HSLV	High Solids Low VOC	BB	Bleed Block
		FR	Fire Rated
		BC	Base Coat
		TC	Top Coat

Note- Contact CRFC for additional products and accessories

A. SeamlessSEAL ULTRA Silicone Coating

The silicone roof coating membrane consists of an elastomeric, liquid applied material, domestically engineered and produced. The coating can be installed in one or multiple coats. The product is suitable for application through airless spray equipment, roller, spreader bar, squeegee, or brush. Refer to table 1 for available types of coatings.

Note: Table 2 shows the physical properties for the SeamlessSEAL ULTRA HSLV and LS silicone coatings. For other silicone coatings, the applicable product data sheet should be referenced for product physical properties.

Table 2

Physical Property	Test Method	SeamlessSEAL ULTRA HSLV Silicone Coating	SeamlessSEAL ULTRA LS Silicone Coating
Volatile Organic Content (VOC), (g/l)	EPA Method 24	<50	<250
Tear Resistance, lbs/in	ASTM D 624	24	37
Tensile Strength, die C, psi	ASTM D 412 ASTM D 2370*	244* @73°F 227* @ 0°F	460 @73°F
Elongation, %	ASTM D 412 ASTM D 2370*	187* @73°F 121* @ 0°F	235 @73°F
Permeability, perms	ASTM E 96B	6.5	6.1
Solar Reflectivity (White)	ASTM C 1549	0.82 (3 year aged) 0.87 (initial)	0.66 (3 year aged) 0.85 (initial)
Emissivity (White)	ASTM C 1371	0.89 (3 year aged) 0.9 (initial)	0.9 (3 year) 0.85 (initial)
Solar Reflectance Index (SRI) (White)	ASTM E 1980	109	106
Low Temperature Flexibility	ASTM D 522 Method B	-15°F (-26°C) Pass	-15°F (-26°C) Pass
Solids Content by Weight %	ASTM D 1644	96±2	80±2
Solids Content by Volume %	ASTM D 2697	93±2	69±2
Cure Time	@100°F & 90% Humidity @40°F & 20% Humidity	Min 2hrs Max 8-12 hrs	Min 2hrs Max 8-12 hrs
Shelf Life		1 year	1 year

B. SeamlessSEAL Acrylic Coatings

1. SeamlessSEAL Acrylic

SeamlessSEAL Acrylic Coating is a 100% acrylic, single-component, water-based, premium quality elastomeric coating for spray, brush, or roller application. This product is designed to provide protection for a wide range of building surfaces such as roofs, vertical walls, masonry, and spray polyurethane foam (SPF) roofing systems. It is excellent for waterproofing and restoring existing roof systems, as well as for weather protection of SPF roofing systems. SeamlessSEAL Acrylic coating is applied in multiple coats, with a minimum base coat (BC) and a top coat (TC) for finishing. SeamlessSEAL TC can be used as a top or base coat. SeamlessSeal BC can be used as a base coat but is not recommended as the top finish coat.

2. SeamlSeAL HT

SeamlSeAL HT Acrylic Coating is a 100% acrylic, single-component, water-based, high tensile strength, elastomeric coating. This product is suitable for spray, brush, or roller application and is designed to provide protection for a wide range of building surfaces, such as roofs, vertical walls, masonry, and spray polyurethane foam (SPF) roofing systems. It is excellent for waterproofing and restoring existing roof systems, as well as for weather protection of SPF roofing systems

3. SeamlSeAL BB

SeamlSeAL BB Acrylic Coating is a 100% acrylic, single-component, water-based, high-quality elastomeric coating for spray, brush, or roller application. SeamlSeAL BB is designed for use as an acrylic base coating to block bleed-through from asphaltic substrates and PVC plasticizer migration. It is excellent for waterproofing and restoring existing roof systems, as well as prepared PVC, metal, and asphaltic surfaces. Use SeamlSeAL BB with SeamlSeAL acrylic topcoats for a premium coating system.

Refer to Table 1 for available types of coatings.

Table 3

Physical Property	Test Method	SeamlSeAL Acrylic Coating (TC)	SeamlSeAL HT	SeamlSeAL BB
Tensile Strength, psi (Max @ 73°F)	ASTM D 2370	273	475	300
% Elongation @ Break (73°F)	ASTM D 2370	262	580	304
Volume Solids, %	ASTM D 2697	55 ±2	55±2	55±2
Weight Solids, %	ASTM D 1644	68±2	65±2	69±2
Volatile Organic Content (VOC), (g/l)	EPA Method 24	<50	<50	<50
Tear Resistance (Die C), lb f/in	ASTM D 6694/ 624	88	130	
Permeance, perms	ASTM D 1653B	17	12	4
Low Temp Flex	ASTM D 522	Pass	Pass	Pass
Solar Reflectivity	ASTM C 1549	0.88	0.87	
Emissivity (white)	ASTM C 1371	0.90	0.88	
Solar Reflectance Index (SRI) (White)	ASTM E 1980	111	110	
Drying Time		Recoat 12-24 hrs Tack Free 2-12 hrs	Recoat 12-24 hrs Tack Free 2-12 hrs	Recoat 12-24 hrs Tack Free 4-5 hrs
Shelf Life		1 year	1 year	1 year

2.03 Primers

A. Prime-Tek Epoxy Primer

Prime-Tek Epoxy Primer is a two component, 1:1 ratio “A” is white, and part “B” is black to dark grey, the combined product is medium grey and is a water-based primer. Adheres well to most metals, organic and synthetic polymers, wood, masonry and vitreous surfaces. This primer may also be used as a masonry block filler. Do not use on copper or silver. Once mixed, material has a useable pot life of 2 hours maximum at 75°F.

Table 4

Physical Property	Test Method	Prime-Tek Epoxy Primer Part A and B
Solids Content by Weight, %	ASTM D 1644	60 ±2
Solids Content by Volume, %	ASTM D 2697	42.5 ±2
Density, lbs/gal	ASTM D 1475	12.3 (A) 7.9 (B)
VOC, g/l	EPA Method 24	<50
Cure Time @ 75°F		Dry to touch 0.5-1.5 hours Full cure 12-24 hours
Shelf Life		1 yr

B. Prime-Tek Acrylic General Purpose Primer (Black)

Prime-Tek Acrylic General Purpose Primer (Black) is suitable when a fast-drying, primer is needed. This product may be used on many surfaces for effective protection: BUR, Metal, Concrete (min 30 day cured), Polyurethane Foam, Acrylic Coatings and Masonry.

Table 5

Physical Property	Test Method	Prime-Tek Acrylic General Purpose Primer
Solids Content by Weight, %	ASTM D 1644	45±2
Solids Content by Volume, %	ASTM D 2697	38±2
Density, lbs/gal	ASTM D 1475	9.4
VOC g/l	EPA Method 24	<50
Cure Time		Dry to touch @ 75°F in 0.5 -1 hours, Full cure in 2-6 hours
Shelf Life		1 yr

C. Prime-Tek Bleed Block Primer (Red)

Prime-Tek Bleed Block Primer (Red) is a water-based, rust-inhibiting primer developed to block “bleed-through” from mod bit, BUR and asphaltic substrates. It can also be used to protect metal substrates. This primer dries quickly allowing for reduced time before elastomeric coating. Prime-Tek Bleed Block Primer is based on cross-linking technologies that allow for low VOC levels and enhanced corrosion resistance and adhesive properties.

Table 6

Physical Property	Test Method	Prime-Tek Bleed Block Primer
Solids Content by Volume, %	ASTM D 2697	38±2
Density per Gallon (A&B), lbs/gal	ASTM D 1475	10.1
VOC, g/l	EPA Method 24	<50
Cure Time		Dry to touch @ 75°F in 0.5 -1 hour, Full cure in 2-8 hours
Shelf Life		1 yr

D. Prime-Tek Tie-in Primer (Translucent black)

Prime-Tek Tie-In Primer is a single-component, solvent-based polyurethane primer that provides outstanding adhesion to various substrates, including polyurethane and polyurea coatings. This product is translucent black in color and is ideal for use as a bonding or tie coat primer over aged polyurea and urethane coatings and can be used over other substrates such as metal, concrete, and wood.

Table 7

Physical Property	Test Method	Prime-Tek Bleed Block Primer
Solids Content by Volume, %	ASTM D 2697	30±2
Solids Content by weight, %	ASTM D 1644	26±2
Density (A&B), lbs/gal	ASTM D 1475	7.7
VOC, g/l	EPA Method 24	643
Cure Time		Full @ 75°F in 2 - 4 hours,
Shelf Life		1 yr

General Product Limitations

Protect from freezing during shipping and storage. Do not apply primer or coatings when it is raining or if the threat of rain exists. Do not apply when the dew point is less than 5°F above ambient temperature. Subsequent coats should be applied within 48 hours of prior applications to ensure full and uniform adhesion. Do not use on new concrete (less than 30 days). Refer to individual PDS and SDS for specific product application, storage and handling requirements.

General Substrate Recommendations

For additional substrates, preparation or approved primers contact CRFC.

Table 8

SeamlesSEAL ULTRA Silicone			
Roof Surface	Cleaner	Pressure Wash	Primer
New EPDM	Prime-Tek Membrane Cleaner	Yes	N/A
Aged EPDM*	Prime-Tek Membrane Cleaner	Yes	N/A
New TPO	N/A	N/A	Prime-Tek TPO
Aged TPO*	Prime-Tek Membrane Cleaner	Yes	Prime-Tek TPO
New PVC/KEE			
Aged PVC/KEE*	Prime-Tek Membrane Cleaner	Yes	Prime-Tek Bleed Block
Hypalon®*	Prime-Tek Membrane Cleaner	Yes	N/A
New Ferrous Metal, Galvanized, or Galvalume finished*	N/A	Yes	N/A
Aged Ferrous Metal, Galvanized, or Galvalume finished*	N/A	Yes	Prime-Tek Bleed Block
New Concrete	N/A	N/A	Prime-Tek General Purpose
Aged Concrete*	N/A	Yes	Prime-Tek Bleed Block
New Smooth BUR	N/A	Yes	Prime-Tek Bleed Block
Aged Smooth BUR*	Prime-Tek Membrane Cleaner	Yes	Prime-Tek Bleed Block
New APP	N/A	Yes	Prime-Tek Bleed Block
Aged APP*	Prime-Tek Membrane Cleaner	Yes	Prime-Tek Bleed Block
New SBS - Smooth	N/A	Yes	Prime-Tek Bleed Block
Aged SBS - Smooth*	Prime-Tek Membrane Cleaner	Yes	Prime-Tek Bleed Block
New SBS – Granulated	N/A	Yes	Prime-Tek Bleed Block
Aged SBS - Granulated*	Prime-Tek Membrane Cleaner	Yes	Prime-Tek Bleed Block
New SPF	N/A	No	**
Repair SPF*	N/A	No	Prime-Tek General Purpose
Aged Silicone*	N/A	Yes	N/A
Aged Acrylic*	N/A	Yes	N/A

*- Field adhesion test required (2.0pli minimum)

** - Use General Purpose or Tie-In Primer between day-to-day applications or if SPF will not be coated within 24 hrs.

Table 9

SeamlesSEAL Acrylic			
Roof Surface	Cleaner	Pressure Wash	Primer
New EPDM	Prime-Tek Membrane Cleaner	Yes	N/A
Aged EPDM*	Prime-Tek Membrane Cleaner	Yes	N/A
New TPO	N/A	N/A	Prime-Tek TPO
Aged TPO*	Prime-Tek Membrane Cleaner	Yes	Prime-Tek TPO
New PVC/KEE			
Aged PVC/KEE*	Prime-Tek Membrane Cleaner	Yes	Prime-Tek Bleed Block
Hypalon®*	Prime-Tek Membrane Cleaner	Yes	N/A
New Ferrous Metal, Galvanized, or Galvalume finished*	N/A	Yes	N/A
Aged Ferrous Metal, Galvanized, or Galvalume finished*	N/A	Yes	Prime-Tek Bleed Block
New Concrete	N/A	N/A	Prime-Tek General Purpose
Aged Concrete*	N/A	Yes	Prime-Tek Bleed Block
New Smooth BUR	N/A	Yes	Prime-Tek Bleed Block
Aged Smooth BUR*	Prime-Tek Membrane Cleaner	Yes	Prime-Tek Bleed Block
New APP	N/A	Yes	Prime-Tek Bleed Block
Aged APP*	Prime-Tek Membrane Cleaner	Yes	Prime-Tek Bleed Block
New SBS - Smooth	N/A	Yes	Prime-Tek Bleed Block
Aged SBS - Smooth*	Prime-Tek Membrane Cleaner	Yes	Prime-Tek Bleed Block
New SBS – Granulated	N/A	Yes	Prime-Tek Bleed Block
Aged SBS - Granulated*	Prime-Tek Membrane Cleaner	Yes	Prime-Tek Bleed Block
New SPF	N/A	No	**
Repair SPF*	N/A	No	Prime-Tek General Purpose
Aged Acrylic*	N/A	Yes	N/A

*- Field adhesion test required (2.0pli minimum)

** - Use General Purpose or Tie-In Primer between day-to-day applications or if SPF will not be coated within 24 hrs.

2.04 Other CRFC Products

- A. **Seal-Tek Acrylic Mastic** is a single-component, acrylic, water-based mastic. This mastic is intended for use as a flashing material for most substrates and as a sealer for seams, fasteners, penetrations, and on other details as part of the restoration coating. Seal-Tek Acrylic Mastic can also be used to fill small cracks, gaps and alligatored asphaltic roof surfaces.

- B. **Seal-Tek Silicone Mastic** is a single-component, high-build, silicone mastic. Upon cure, Seal-Tek Silicone Mastic forms a durable, weatherproof sealant. Designed for use with CRFC silicone restoration coating systems, this mastic can also be used to seal roof penetrations, seams, fasteners, and other roofing substrates and surfaces.

Note: Seal-Tek Silicone Mastic can only be coated with SeamlSeAL ULTRA silicone coating.

- C. **Seal-Tek Silicone Sealant** is a medium-modulus silicone sealant that forms a durable, weatherproof sealant used in conjunction with CRFC silicone restoration coating system. This sealant can be used to seal roof penetrations, seams, fasteners, and other roofing substrates and surfaces.

Note: Seal-Tek Silicone sealant can only be coated with SeamlSeAL ULTRA silicone coating.

- D. **Seal-Tek Micro Fibers** are micro-fine, high-tensile, polyethylene fibers used as a general thickener in silicone and acrylic coatings to increase tensile strength, reduce sag, and thicken the coating into a trowel, roll-on or brushable mastic.

The thicker mixture allows for fabrication of cants and filling around irregular surfaces. The process can adapt the mastic product to the project's need and conditions. The Seal-Tek Micro Fibers can also be added to SeamlSeAL® and SeamlSeAL ULTRA coatings to create an excellent repair material for hail and mechanical damages to spray polyurethane foam (SPF) and coated roofing systems.

- E. **Seal-Tek Reinforcing Fabric** is a stitch-bonded, 100% polyester material made specifically for use with elastomeric coatings in roof membrane construction. Seal-Tek Reinforcing Fabric has high absorption capability, allowing it to easily wet into and become encapsulated by the liquid roofing membrane, forming tough, waterproof details or overall reinforcement. Seal-Tek Reinforcing Fabric is used to reinforce detail areas such as seams, splits, drains, vents, and other penetrations through the roof surface.

- F. **Prime-Tek Membrane Cleaner** is a low-viscosity, sprayable liquid used to clean existing roof surface prior to pressure washing and application of restoration coatings. This cleaner improves adhesion to roof membranes and is clear to purple in color.

2.05 Equipment

For spray equipment considerations, please refer to SPFA-144- Coating Equipment Guideline or consult the spray equipment manufacturer directly. For additional recommendations, refer to CRFC specific Product Data Sheet.”

2.06 Granules

Granules are optional. They may be used to enhance aesthetics, impact resistance, slip resistance or highlight walkways. Granules shall be number 11 screen size, ceramic-coated roofing granules, color to match topcoat. Quartz or silica aggregate are also acceptable. Apply at a rate of 30-40lbs per 100 square

feet.

2.07 Other Related Products

- Rollers with 1/2" Nap
- Brushes
- 2,000 psi rated power washer
- Detergent

PART III EXECUTION

Prior to commencing with the installation of any of the SeamsSeal Acrylic or SeamsSeal ULTRA Silicone Restoration Systems, refer to Paragraph 1.06 "Warranty" for applicable requirements suitable for the appropriate warranty coverage.

Requirements listed in this specification are considered minimum and are intended for the sole purpose of obtaining a Carlisle Roof and Foam Coating (CRFC) Restoration Warranty. Additional requirements dictated by Regulatory Agencies, Building Insurance or Specifiers must be complied with and are beyond the scope of this specification.

3.01 General

- A. Safety Data Sheets (SDS) must always be on location during transportation, storage and application of materials. The applicator shall follow all safety regulations as recommended by OSHA, and/or other agencies having jurisdiction.
- B. To ensure most current installation requirements are met, Product Data Sheets should be available on site.
- C. Comply with building owner requirement for onsite material storage and campus regulations. Place dumpster and other equipment in areas which have been designated by the building owner.
- D. The worksite must be kept in an organized and orderly fashion. All waste products must be removed and disposed of, in accordance with local ordinances.
- E. Subject to project conditions, it is recommended to begin the application of this restoration system at the highest point of the roof and work to the lowest point.

3.02 Surface Inspection

The assessment and examination of the existing roof system to be restored shall be performed by the CRFC authorized roofing applicator or CRFC technical representative. The assessment and examinations shall focus on the condition of the roof surface and the components to be restored.

- A. When in-depth investigation is needed to assess the entire existing roof assembly. A roof consultant shall be obtained by the building owner to conduct such investigation. Investigation shall identify all necessary system repairs prior to commencing restoration work.
- B. If certain major repairs have been identified that required membrane removal, replacement or the addition of new insulation, such repairs must be performed with by an authorized applicator trained on the specific roof system and in accordance with manufacturer guidelines to insure the repaired section is sound and leak free.
- C. This restoration coating system is not suitable for roofs with severe ponding conditions where water accumulates on the surface of the membrane for periods greater than 48 hours, in areas scattered across 20% of the roof. If restoration is being considered the affected areas shall be repaired to achieve positive drainage and properly sealed. Refer to appropriate attachment or product warranty for specific system repairs.

Note: Consult **Attachment I** - "Assessment and Investigation" for the applicable guidelines for assessing various roof assemblies.

3.03 Substrate Preparation

- A. Attachments II-V, included at the end of this Restoration Coating section, contain information on the appropriate substrate preparation (cleaning, priming, and repairing), categorized by the type of the existing roof membrane.

Attachment II – "Substrate Preparation – Asphaltic Roofing"

Attachment III – "Substrate Preparation – Metal Roofing"

Attachment IV – "Substrate Preparation – SPF"

Attachment V – "Substrate Preparation – Single Ply Membrane"

- B. Refer to tables 8 & 9 included in Part II for general substrate recommendations concerning cleaning and priming of the various types of roofing surfaces. Certain roofs may only require cleaning and others may require the use of cleaning and primer to enhance coating adhesion. Certain roofs may require primer in addition to cleaning to prevent staining, bleed through or inhibit the formation of surface rust. The appropriate table may be referenced as a general guide. Contact CRFC for additional recommendations.
- C. For all aged substrates, adhesion tests are required, as outlined in the quality assurance article, to determine the extent of the surface treatment and the use of primers. Adhesion tests are strongly recommended on all new substrates to verify suitability of general substrate recommendations. Such testing is recommended at an earlier stage of the project, preferably prior to the bid, and may be performed during the initial roof inspection and surface assessment performed by the Authorized Applicator and/or CRFC representative.
- D. Do not commence with surface repairs unless all system related issues and imperfections have been addressed by the building owner and their design representative.
- E. Clean and prepare surface to receive the restoration coating. Remove all dirt, loose and flaking particles, grease, oil, laitance, pollution fallout, and other contaminants that may interfere with proper adhesion.

Note: The use of a stiff bristle (soft for SPF) push broom and pressure washing for cleaning and surface

preparations is required.

- F. When required, clean the existing surface with applicable cleaning solution and power-wash with clean water. The appropriate attachment at the end of this section may be referenced for specific substrate preparation requirements.

3.04 Surface Repair & Detail Work

- A. Depending on the type of roof system being restored, asphaltic, metal, SPF or a single ply, vulnerable areas such as seams, flashing overlaps, expansion joints, vertical curbs, and other roof penetrations must be prepared to extend the water tight performance. In addition, other identified surface deficiencies such as blisters, minor splits, tears, cracks, surface rust and punctures must be prepared as outlined in the specific attachment.
- B. In these repair locations, reinforcing fabric imbedded into the base coat and covered with the topcoat, may be used to overlay deficient areas. A mixture of Micro Fibers and coating may also be used as identified in the “specific preparation attachment”. The ratio of such a mixture (roller, brush, or trowel) will vary in its concentration depending on the area to be treated. The appropriate attachment may be referenced for the specific ratio. After completing the necessary prep work using coating and reinforcing fabric or the Micro Fibers coating mixture, allow repaired area to cure. Curing time will vary based on temperature and humidity level. Refer to the CRFC PDS for the acceptable cure time.
- C. Attachments II-V, included at the end of this Restoration Coating section, contains information on the appropriate surface repair and detail work, categorized by the type of the existing roof membrane.

Attachment II – “Substrate Preparation – Asphaltic Roofing”

Attachment III – “Substrate Preparation – Metal Roofing”

Attachment IV – “Substrate Preparation – SPF”

Attachment V – “Substrate Preparation – Single Ply Membranes (EPDM, TPO and PVC)”

3.05 Coating Application

A. General

1. Do not apply coating if weather conditions will not permit complete cure (24-hour period) before rain, dew, fog or freezing temperatures occur.
2. When performing surface treatments prior to coating, use acrylic mastic for acrylic coatings and silicone mastics for silicone coatings. All mastics and sealants must be allowed to fully cure before applying coating.
3. Using a high-pressure compressed air or an air blower, blow all dust, dirt and other contaminants off the treated roof surfaces.
4. Apply coating when temperature is within the specified range for the specific product (consult the applicable product PDS) with no inclement weather imminent.

5. The use of brushes is recommended for delicate detail work and edges at parapets, HVAC units, stacks, skylights, penetrations, etc.
6. Sealant/mastic must be cured, clean and free of all moisture prior to application of coating.
7. Apply the coating to achieve a uniform application to equal a minimum total finished dry film thickness required in the warranty table paragraph 1.06.
8. Apply approved granules at the rate of 30-40lbs per 100 square feet to achieve the desired surface texture. When used for walkways, the granules should be used in a contrasting color so that the walkway is visible.
9. Allow the topcoat to cure prior to inspecting the finished surface. Repair any defects with appropriate CRFC sealant/mastic and/or additional application of coating.

3.06 Clean up

Allow coating to dry before subjecting the surface to traffic. Drying conditions will vary depending on temperature and humidity levels. Consult the specific Product Data Sheets for estimated cure time.

- A. Walk the roof to ensure all tools are removed and lids, empty containers and other debris are picked up and properly disposed of.
- B. Check drains and air intake vents to ensure that they are open with no obstructions. Check roof perimeter and terminations. Make sure all terminations are properly sealed and all masking tape used for terminations, is removed.
- C. If spray equipment is used, ensure hoses are properly coiled and spray equipment is adequately cleaned as per manufacturer's instructions.
- D. When applicable, provide owner representative with instructions on accessing the roof following the coating application.

3.07 Roof Walkways

- A. Scope of Work:
 1. Walkways are to be specified at all traffic concentration points (i.e., roof hatches, access doors, rooftop ladders, etc.), and if regular maintenance (once a month or more) is necessary to service rooftop equipment.
 2. Where applicable, a weather-resistant, breathable, resilient pad composed of synthetic rubber strands or other suitable material shall be installed to create protected surface over the coating system. Walkways shall consist of a different color to provide contrast against the coated surface.
 3. As an option, a walkway system can be formed by an additional layer of coating and granules. A contrasting color to the coating shall be selected so that the walkway system can easily be identified.

B. Walkways Limitations & Cautions:

1. Factory-made walkways are considered a maintenance item and are excluded from the CRFC warranty. Secondary roof coating as a walkway is included in CRFC's warranty.
2. Window washing equipment will require special maintenance. Runways or window washing tracks must be segregated and separately constructed, with approved roofing or waterproofing system. When such conditions exist, it must be reviewed by CRFC.
3. Do not alter or change the location of walkways unless requested by the building owner design representative.

END OF SECTION

Copyright 2019 Carlisle Construction Materials Incorporated

SeamlesSEAL, SeamlesSEAL ULTRA, and Carlisle are Trademarks of Carlisle Construction Materials Incorporated

This Spec Supplement represents the applicable information available at the time of its publication. Owners, Specifiers and Carlisle authorized roofing applicators should consult CRFC or their Manufacturer's Representative for any information that has subsequently been made available.

Restoration Coating

Attachment I Assessment and Investigation

October 2019

Information contained in this attachment is intended for use as part of Carlisle Roof Foam and Coatings (CRFC) Restoration Coating system. This attachment specifically pertains to the investigation and assessment of an existing roof surface to verify suitability for restoration. While this attachment only addresses investigation, information pertaining to substrate preparation, repairs, and cleaning are available in other attachments in this section.

GENERAL

The restoration coating is intended to enhance and extend the service life of an existing, sound and watertight roof or one that may experience occasional minor leaks. This system is not suitable for the restoration of roofs which have exceeded or are approaching the end of their service life.

1. The assessment and examination of the existing roof surface to be restored shall be performed by the CRFC authorized roofing applicator or CRFC technical representative. The assessment and examinations shall focus on the condition of the roof surface and the components to be restored.

Note: When in-depth investigation is needed to assess the entire existing roof system, a roof consultant or qualified professional shall be attained by the building owner to conduct such investigation. The investigation shall identify all necessary system repairs prior to commencing with the restoration work.

2. If certain major repairs have been identified that required membrane removal and replacement and the addition of new insulation, such repairs must be performed with an applicator, authorized and trained on the specific roof system, and in accordance with manufacturer's warranty requirements.
3. Moisture surveys are strongly recommended, when moisture entrapment is suspected, on roofs installed over vapor barriers, or over existing membranes and may have experienced a leak.
4. Moisture surveys may be conducted by a qualified third-party using IR Scans, Nuclear scans or by taking core cuts. Core cuts may also be taken by the CRFC contractor and sent to a third party for moisture and adhesion analysis.
5. When test cuts are to be taken, there is a minimum of 3 cuts required per 10,000 sq. ft. of roof area with additional cut recommended for every additional 10,000 sq. ft. of roofing.

6. Adhesion tests are required and must be coordinated in advance, to determine the extent of surface preparation/cleaning needed to ensure adequate adhesion of the coating and if priming is needed. A minimum three adhesion test area are required per 10,000 sq. ft of roof area with an additional test recommended for every additional 10,000 sq. ft. of roof surface to be restored.

Caution: On Asphaltic roofing, even when achieving acceptable adhesion/peel values, the use of Prime-Tek Bleed Block Primer is strongly recommended to prevent bleed thru and staining of coating. The Bleed Block Primer is required for slightly rusted metal or those with rust spots.

Inspection and Assessment

1. This restoration coating system is not suitable for roofs with severe ponding conditions where water accumulates on the surface for periods greater than 48 hours, in areas scattered across of the roof greater than 20%. If restoration is being considered, the affected areas shall be repaired to achieve positive drainage and properly sealed. Refer to appropriate attachment for specific system repairs.
2. Granular surfaces shall be free of any loose granules. Granules that may have become loose due to surface cleaning must be removed. Aggregate (gravel) surfaces are generally not suitable for a coating.
3. Exposed and aged SPF shall be evaluated for scarifying and filling prior to coating.
4. Restoration coating of an existing Single-Ply membrane is not recommended if any of the following conditions are observed during inspection:
 - a. The membrane reinforcement scrim is visible or exposed through, in random or multiple locations of significant surface area.
 - b. The membrane is exhibiting brittleness and surface cracking is evident across the surface.
 - c. Attachment method has become unreliable or membrane damage is so excessive that tear off is more appropriate.
 - d. The membrane substrate has been weakened, unattached, or fully saturated.
5. Restoration coating of an existing metal roof system is not recommended, if any of the following conditions are observed during inspection:
 - a. Excessive rusting has compromised the structural integrity of the metal panels.
 - b. The metal panels have been deformed or fatigued. These panels shall be replaced.
6. Restoration Coating of an existing coating/finish is not recommended if any of the following conditions are observed during inspection:
 - a. The existing coating/finish has scattered and has well-advanced blistering or flaking.
 - b. Existing roofs with silicone coating can only be coated with silicone coatings. No other coatings are suitable/compatible with the existing silicone.

- c. Existing roofs with Kynar or other fluoropolymer finishes are not compatible with other coatings and can not be restored with this coating system.
7. Restoration Coating of an existing asphaltic/BUR surface is not recommended if any of the following conditions are observed during inspection:
- a. The surface has become alligatored, badly weathered or separation between asphaltic plies has occurred
 - b. Cap sheets are badly weathered
 - c. Uncured asphalt emulsions, roof cements, or mastics are present

These roofs will require various repairs and the removal of any roofing cement before the restoration work. Severely deteriorated roofs or coal tar pitch roofs are not to be restored with this Restoration Coating system.

8. An inspection checklist should be prepared and secured for reference along with pictures of key locations where in-depth investigation was suggested.
9. For substrate preparation, cleaning and repairs, by the CRFC applicator, the appropriate attachment (II thru V) shall be referenced. If necessary, the CRFC applicator, may solicit assistance and input from the regional CRFC representative.

End of Attachment I

Restoration Coating

Attachment II

Substrate Preparations – Asphaltic Roofing

October 2019

*This attachment is part of the Carlisle Roof Foam and Coatings (CRFC) coating restoration system and contains specific information on the various substrate preparations required to restore existing **asphaltic roofs**.*

As a prerequisite, the existing roof surface must be inspected, as outlined in Attachment I, to determine the suitability for restoration and the possible issuance of CRFC Warranty. To obtain a system warranty, criteria set forth by CRFC and outlined in the main specification must be complied with, along with the information contained in this attachment.

A. General

Criteria contained in this Substrate Preparation Attachment is not intended for restoration of existing cold tar pitch roofs. If such projects are encountered CRFC must be contacted for recommendations and specific application guidelines.

Note: As outlined in Part I of the Coating Restoration Specification, adhesion tests are required and must be coordinated in advance, preferably, before bidding to determine the need for surface priming, to ensure adequate adhesion of the coating. A minimum three adhesion test areas are required per 10,000 sq. ft area with an additional test area recommended for every additional 10,000 sq. ft. **Even with achieving acceptable adhesion values, the use of Prime-Tek Bleed Block Primer is strongly recommended to prevent bleed thru and staining of the coating. SeamlesSEAL Bleed Block base coat may also be used with SeamlesSEAL acrylic restoration coatings to prevent bleed thru and staining of the coating.**

1. Substrate preparation contained in this attachment is intended for properly functioning roof systems to prolong and extend their service life.
2. The existing asphaltic roof must be investigated in accordance with the guidelines contained in **Attachment I** of this specification to determine if the existing roof is suitable for restoration.
3. Existing asphaltic roofs with large areas of scattered blistering or those with severe ponding conditions are not suitable for restoration as is. Such roofs must be closely examined to determine the extent of needed repairs prior to restoration, or possible replacement.
4. If moisture entrapment is suspected, and core cuts have been obtained for testing, voids in the substrate must be addressed in these areas.
5. Inspect all surfaces to be coated to ensure they are clean, smooth, sound, properly prepared, and free of moisture, dirt, debris, or other contamination.

6. When CRFC SeamlesSEAL **Acrylic** coatings are being considered for restoration, only CRFC Seal-Tek **Acrylic** mastic can be used. Acrylic coatings are not compatible for application over silicone mastics, sealants or existing silicone coatings.
7. When CRFC SeamlesSEAL ULTRA **Silicone** coatings are being considered for restoration, the use of CRFC Seal-Tek **Silicone** mastic/sealant is recommended.
8. **For additional information the latest edition of “low slope roof manual for repairs” by NRCE may be referenced.**

B. Special Considerations

1. While it is strongly recommended to design roofs with positive drainage to prevent ponding conditions, some incidental ponding may be encountered on existing roofs due to deck deflection or changes in weather patterns.
2. Do not proceed with sealant, mastic or coating application if surface moisture is present, or if the following conditions are anticipated:
 - a. When the dew point is within 5°F of the surface temperature.
 - b. When there is a possibility of rain.
 - c. Temperatures falling below 32°F with in a 24-hour period. Refer to specific PDS for additional guidance.

C. Cleaning

1. All surfaces to be restored must be clean, sound, dry and free of any dirt, grease, oil, debris or other contaminants which would interfere with proper adhesion. Approved cleaning methods include:
 - a. Spudding/Scraping
 - b. Power brooming
 - c. Wet Vacuuming
 - d. Vacuum
 - e. Power washing
 - f. Prime-Tek Membrane Cleaner
2. In low areas where contaminants may have settled, use a brush to ensure the surface is properly cleaned.
3. The substrate must be carefully pressure washed (2,000 psi depending on roof condition) with water. All dirt, dust, chalking, loose materials, etc. must be removed without damaging the surface. Take care not to damage the roof surface or force water into the roof system.
4. Use hot water and a mild detergent to remove grease and/or oils from the roof substrate. If mildew or algae or fugus are present, use a suitable solution to treat these areas, then pressure wash surface.
5. Rinse off the surface when detergent or cleaner is used and wash down drain according to local

ordinance.

Note: Loose granules that may have shifted and accumulated should be removed and disposed of, only secured granules should remain.

D. Substrate Repairs

All wet areas must be removed and repaired prior to application of coating. All identified areas that require repairs, follow cleaning procedures out lined in paragraph C "Cleaning" to ensure the surface is properly cleaned prior to application of repair materials.

1. Any areas where BUR or MB has blistered, buckled, and is wet and/or otherwise damaged must be removed and repaired.
2. On built-up roofs with gravel, the entire roof should be spudded to achieve a relatively smooth surface. After cleaning and preparing, apply asphalt emulsion with imbedded reinforcing fabric as necessary to level off the entire surface.
3. New BUR or MB repair materials must be allowed to weather for at least 30 days and cleaned per Section C prior to application of restoration coating.
4. All areas where BUR or MB substrate surfaces is significantly crazed/cracking (gaps 1/16" or greater in width and/or depth) must be repaired with a trowel or brushable grade mixture of micro fibers and coatings, to bring the substrate to a smooth workable surface.

Note: For other types of built up roofs, apply brush grade mixture of micro fibers and coating (field blended mastic) at all transitions/junctions and around skylights and curbs. Apply roller grade mixture of micro fibers to seams.

5. Overlay all field seams and transitional details (deck to wall junctions, curbs, skylights, penthouse, etc.) with roller grade mixture of micro fibers and coatings. The mixture shall be applied using a 4" wide 1/2" nap roller (centered over the leading edge). Refer to CRFC applicable details for alternative seam overlayment options.
6. Around vent pipes, pitch pockets, drains and other unusual penetrations, use a brush grade mixture of micro fibers and coating. The repair shall cover an area 4" in all directions.

Note: In leu of brush grade mixture of CRFC Micro Fibers and coating, use SPF to fill any gaps that may result from the removal of existing flashing material.

7. Areas where core cuts were taken, and no moisture is detected, shall be filled with CRFC Mastic and allowed to cure 24 hours. The area should then be capped with trowel grade mixture of Micro Fibers and coatings or a layer of Reinforcing Fabric imbedded in two layers of coating.
8. At raised expansion joints, if necessary, seal perpendicular joints of the expansion joint cover using at least 2 layers of Reinforcing Fabric (minimum of 4" and 8" respectively) imbedded in multiple layers of coating.
9. All blisters shall be cut, dried out, re-adhered and sealed with appropriate roof mastic. Large blister (12" or greater), after allowing mastic to dry, may require an application of Seal-Tek Reinforcing Fabric encapsulated in a base coat and a topcoat.
10. At all other locations where surface cracks or splits are evident repair using trowel grade mixture of Micro Fibers and of coating or with Reinforcing Fabric imbedded in coating.

Note: The ratio of Micro Fibers and coating will vary based on high or low solid content of the coating. A CRFC representative or the applicable tech bulletin should be consulted for mix ratio.

E. Final preparation before coating

Re-examine the roof to ensure the surface is clean and dry as described in Article C “Cleaning”. If necessary, repeat the cleaning procedures and allow the surface to dry before coating.

1. Ensure all roof penetrations, curbs, skylights, cants, edge metal and other roof mounted equipment are in place and secure.
2. Coordinate work with building maintenance personnel to ensure that air intake units are temporarily sealed to prevent coating overspray and fumes from entering occupied spaces.
3. Confirm that all adjacent surfaces surrounding the work area are adequately protected from overspray and frequent construction traffic.
4. Apply primer if required.

F. Coating Application and Cleanup Work

Refer to part III of the Coating Restoration Specification.

End of Attachment II

Restoration Coating

Attachment III

Substrate Preparations – Metal Roofing

October 2019

*This attachment is part of the Carlisle Roof Foam and Coatings (CRFC) coating restoration system and contains specific information on the various substrate preparations required to restore existing **metal roofs**.*

As a prerequisite, the existing roof surface must be inspected, as outlined in Attachment I, to determine their suitability for restoration and the possible issuance of CRFC Warranty. To obtain a system warranty, criteria set forth by CRFC and outlined in the main specification must be complied with, along with the information contained in this attachment.

A. General

As outlined in Part I of the Coating Restoration Specification, adhesion tests are required and must be coordinated in advance, preferably, before bidding to determine the need for surface priming, to ensure adequate adhesion of the coating. A minimum three adhesion test areas are required per 10,000 sq. ft area with an additional test recommended for every additional 10,000 sq. ft. Even with achieving acceptable adhesion values, the use of Prime-Tek Bleed Block Primer is strongly recommended to resist further rust.

1. Substrate preparation contained in this attachment is intended for properly functioning roof systems in order to prolong and extend its surface life.
2. The existing metal roof must be investigated in accordance with the guidelines contained in **Attachment I** of this specification to determine if the existing roof is suitable for restoration.
3. Existing metal roofs with large areas of heavy rust (greater than 20% of roof surface) or rusted through panels are generally not candidates for successful restoration. Such roofs must be closely examined to determine the extent of needed repairs and possible panel replacement.
4. When the CRFC SeamlesSEAL **Acrylic** coating is being considered for restoration, only CRFC Seal-Tek **Acrylic** mastic can be used. Acrylic coatings are not compatible for application over silicone mastics, sealants or existing silicone coatings.
5. When the CRFC SeamlesSEAL ULTRA **Silicone** coating is being considered for restoration, the use of CRFC Seal-Tek **Silicone** mastic/sealant is recommended.
6. Inspect surfaces which will receive the SeamlesSEAL ULTRA Silicone & SeamlesSEAL Acrylic coating to make sure they are clean, smooth, sound, properly prepared, and free of moisture, dirt, debris, or other contamination.

B. Special Considerations

1. Do not proceed with sealant, mastic or coating application if surface moisture is present, or if the following conditions are anticipated:
 - a. When the dew point is within 5°F of the surface temperature.
 - b. When there is a possibility of rain.
 - c. Temperatures falling below 32°F with in a 24-hour period. Refer to specific PDS for additional guidance.
2. Remove excessive amounts of asphaltic-based soft mastic, other deteriorated patching or flashing materials if present.
3. If the existing roof has been coated with Aluminized asphalt, contact CRFC for an appropriate primer.

C. Cleaning

1. All surfaces to be restored must be clean, sound, dry and free of any dirt, grease, oil, debris or other contaminants which would interfere with proper adhesion. Approved cleaning methods include:
 - a. Brooming
 - b. Power washing
 - c. Scrapping
 - d. Sand blasting
2. In low areas where contaminants may have settled, use a soft bristled brush to ensure the surface is properly cleaned. Loose coating should be removed prior to application of coating.

D. Substrate Repairs

1. **Medium** or **heavily** rusted areas shall be wire brushed, sandblasted or mechanically abraded to remove all loose rust. Metal panels deteriorated to the point that their structural integrity is compromised shall be replaced.
2. All **lightly** rusted areas, where rust was mechanically removed, shall be primed with Prime-Tek Bleed Block Primer.
3. Check all seams to ensure that they are tight and flush. Excessive gaps or deflection between panels shall be eliminated by installing additional fasteners or rivets as necessary to limit deflection to 1/4" (6mm) or less.
4. All metal surfaces shall be cleaned with minimum 2,000 psi water to remove any existing loose paint or coating. Heavy deposits of dirt or contamination may require agitation with a stiff bristle broom. Allow the roof to dry thoroughly.
5. Fill gaps between 1/4" and 1/2" (6-13mm) at panel seams, joints and protrusions with CRFC approved sealant or tape. Fill gaps larger than 1/2" (13mm) at the ridge cap, roof edge and/or interface of dissimilar materials with a polyethylene backer rod.
6. All mechanical fasteners shall be checked for integrity. Retighten or replace as necessary. "Stripped out" fasteners shall be replaced using a larger diameter fastener. All fasteners must be fully encapsulated

with appropriate CRFC mastic.

7. Overlay all field seams and transitional details (deck to wall junctions, curbs, skylights, penthouse, etc.) with roller grade mixture of Micro Fibers and coatings. The mixture shall be applied using a 4" wide 1/2" nap roller (centered over the leading edge). Refer to CRFC applicable details for alternative seam overlayment options.
8. Around vent pipes, pitch pockets, and other unusual penetrations, use a brush grade mixture of micro fibers and coating. The repair shall cover an area 4" in all directions.
9. Caulk or fill all cracks, holes or other surface imperfections with appropriate CRFC sealant/mastic. All sealant/mastic must be thoroughly dry before application of coating.
10. Any new metal must be clean and oil-free. Prime ferrous metal with Prime-Tek Bleed Block at the rate of 1 gallon per 100-200 square feet. For non-ferrous metals, contact CRFC.

E. Final preparation before coating

Re-examine the roof to make sure the surface is clean and dry as described in Article C "Cleaning".

1. Ensure all roof penetrations, curbs, skylights, cants, edge metal and other roof mounted equipment are in place and secure.
2. Coordinate work with building maintenance personnel to ensure that air intake units are temporarily sealed to prevent coating overspray and fumes from entering occupied spaces.
3. Confirm that all adjacent surfaces surrounding the work area are adequately protected from overspray.

F. Coating Application and Cleanup Work

Refer to part III of the Coating Restoration Specification.

End of Attachment III

Restoration Coating Attachment IV **Substrate Preparations – SPF**

October 2019

*This attachment is part of the Carlisle Roof Foam and Coatings (CRFC) coating restoration system and contains specific information on the various substrate preparations required to restore existing **Spray Polyurethane Foam (SPF) roofs**.*

As a prerequisite, the existing roof surface must be inspected, as outlined in Attachment I, to determine their suitability for restoration and the possible issuance of a CRFC Warranty. To obtain a system warranty, criteria set forth by CRFC and outlined in the main specification must be complied, along with the information contained in this attachment.

A. General

1. Adhesion tests are required and must be coordinated in advance. This is to determine if additional surface preparation/cleaning may be needed, and to ensure adequate adhesion of the coating. A minimum three adhesion test areas are required per 10,000 sq. ft area with an additional test area is recommended for every additional 10,000 sq. ft
2. The existing SPF roof must be investigated in accordance with the guidelines contained in **Attachment I**, of this specification, to determine the existing roof is suitable for restoration.
3. For additional guidance, reference:
 - a. SPFA-122- Renewal of Spray Polyurethane Foam and Coating Roof Systems for additional guidance.
 - b. ASTM D-6705- Standard Guide for Repair and Recoat of Spray Polyurethane Foam Roofing Systems
4. Existing SPF roofs, with large areas of flaking coating and scattered blisters conditions, are generally not candidates for successful restoration. Such roofs must be closely examined to determine the extent of needed repairs and/or scarfing. Any ponding areas shall be inspected and corrected for positive drainage.
5. Existing SPF roofs, with silicone coatings, must be repaired using CRFC Seal-Tek Silicone sealant, CRFC Seal-Tek Silicone mastic, and coated with CRFC SeamlesSEAL ULTRA Silicone.
6. When the CRFC SeamlesSEAL **Acrylic** coating is being considered for restoration, only CRFC Seal-Tek **Acrylic** mastic can be used for repairs. Acrylic coatings are not compatible for application over silicone mastics, sealants or existing silicone coatings.

7. Inspect surfaces, which will receive the SeamlesSEAL ULTA Silicone & SeamlesSEAL Acrylic coating, to

make sure they are clean, smooth, sound, properly prepared, and free of moisture, dirt, debris, or other contamination.

B. Special Considerations

1. While it is strongly recommended to design roofs with positive drainage, to prevent ponding conditions, some incidental ponding may be encountered on existing roofs due to deck deflection or changes in weather patterns. In such cases the use of silicone coating is highly suggested due to its excellent resistance to moisture absorption.
2. Do not proceed with sealant, mastic or coating application if surface moisture is present, or if the following conditions are anticipated:
 - a. When the dew point is within 5°F of the surface temperature.
 - b. When there is a possibility of rain.
 - c. Temperatures falling below 32°F with in a 24-hour period. Refer to specific PDS for additional guidance.

C. Cleaning

1. All surfaces, to be restored, must be clean, sound, dry and free of any dirt, grease, oil, debris or other contaminants which would interfere with proper adhesion. Approved cleaning methods include:
 - a. Prime-Tek Membrane Cleaner
 - b. Brooming
 - c. Power washing
 - d. High pressure air
2. In low areas where contaminants may have settled, use a soft bristled brush to ensure the surface is properly cleaned. Loose coating shall be removed prior to application of coating.

D. Substrate Repairs

1. Any wet areas must be removed and repaired prior to application of coating.
2. Voids created as a result of core cuts may be repaired with replacement foam cores and sealant or filled with CRFC Mastic/Sealant and capped with CRFC Reinforcing Fabric and Mastic. As an alternative SPF can be used to fill the voids and leveled to match the surrounding surface. An additional application of CRFC coating is used to seal the patch.
3. Areas of exposed SPF must be brushed with stiff bristle broom to remove any degraded SPF prior to application of CRFC restoration coating system.
4. Caulk or fill all cracks, holes or other surface imperfections with Seal-Tek Sealant. All sealant must be thoroughly dry before application of coating.
5. When restoring an SPF roof, start repair of large damaged and deteriorated areas by removing existing coating and SPF down to dry, good quality SPF. This requires close observation to ensure the removal

operation is extended both horizontally and vertically to the point where all wet, contaminated and deteriorated SPF has been removed.

6. The damaged SPF must be removed by mechanical scarifying equipment to a minimum depth of ½" (13mm) or until good SPF is determined, whichever is greater. Removal of SPF by hand is not acceptable. These areas shall receive an extra two coats of CRFC's roof coating before coating the entire roof. Unless otherwise specified or required by CRFC, coating shall be applied with multiple coats until desired thickness is required.
7. Large or deep areas of foam removal may require the application of additional foam prior to coating. Apply a minimum of ½" (13mm) new SPF. Do not remove an area larger than can be re-foamed and base coated in the same day. New SPF must be of same density as existing foam.

Caution: Use of low-pressure froth packs is generally not acceptable

8. Reseal around all mechanical equipment and roof penetrations with appropriate Seal-Tek sealant.

E. Final preparation before coating

1. Re-examine the roof to make sure the surface is clean and dry as described in Article C "Cleaning".
2. Ensure all roof penetrations, curbs, skylights, cants, edge metal and other roof mounted equipment are in place and secure.
3. Coordinate work with building maintenance personnel to ensure that air intake units are temporarily sealed to prevent coating overspray and fumes from entering occupied spaces.
4. Confirm that all adjacent surfaces surrounding the work area are adequately protected from overspray and frequent construction traffic.

F. Coating Application and Cleanup Work

Refer to part III of the Coating Restoration Specification.

End of Attachment IV

Restoration Coating

Attachment V

Substrate Preparations – EPDM, TPO & PVC

October 2019

*This attachment is part of the Carlisle Roof Foam and Coatings (CRFC) coating restoration system and contains specific information on the various substrate preparations required to restore existing **Single Ply roofs**.*

As a prerequisite, the existing roof surface must be inspected, as outlined in Attachment I, to determine their suitability for restoration and the possible issuance of CRFC Warranty. To obtain a system warranty, criteria set forth by CRFC and outlined in the main specification must be complied with, along with the information contained in this attachment.

A. General

Substrate preparation contained in this attachment is intended for properly functioning roof systems to prolong and extend their service life.

The existing single-ply roof must be investigated in accordance with the guidelines contained in **Attachment I** of this specification to determine if the existing roof is suitable for restoration.

1. Adhesion tests are required and must be coordinated in advance, to determine if additional surface preparation/cleaning may be needed, and to ensure adequate adhesion of the coating. A minimum of three adhesion test areas are required per 10,000 sq. ft area with an additional test area recommended for every additional 10,000 sq. ft.
 - a. Aged or new EPDM must be cleaned using Prime-Tek Membrane Cleaner and power washed.
 - b. Aged TPO must be cleaned using Prime-Tek Membrane Cleaner, power washed and then primed with Prime-Tek TPO primer.
 - c. New TPO must be primed with Prime-Tek TPO primer.
 - d. Aged PVC/KEE membrane must be cleaned using Prime-Tek Membrane Cleaner, power washed and then primed with Prime-Tek Bleed Block primer. Primer is only required when using SeamlessSEAL Acrylic coatings.

Note: Contact CRFC for additional cleaning and primer recommendations

2. Existing single ply roofs with large areas of delamination, those with severe ponding conditions or those with large areas of wind damage are not candidates for restoration. Such roofs must be closely examined to determine the extent of needed repairs, or possible replacement.

3. Projects where the membrane has crazed and cracked in areas greater than 20% of the roof should be assessed and membrane replaced as necessary.
4. When the CRFC SeamlesSEAL **Acrylic** coating is being considered for restoration, only CRFC Seal-Tek **Acrylic** mastic can be used for repairs. Acrylic coatings are not compatible for application over silicone mastics, sealants or existing silicone coatings.
5. When CRFC SeamlesSEAL ULTRA **Silicone** coating is being considered for restoration, the use of Seal-Tek **Silicone** mastic/sealant is recommended.
6. Inspect surfaces which will receive the SeamlesSEAL ULTRA Silicone or SeamlesSEAL Acrylic coating to make sure they are clean, smooth, sound, properly prepared, and free of moisture, dirt, debris, or other contamination.

B. Special Considerations

1. While it is strongly recommended to design roofs with positive drainage to prevent ponding conditions, some incidental ponding may be encountered on existing roofs due to deck deflection or inadequate roof drainage. If ponding remains after 48 hours tapered insulation or spray polyurethane foam (SPF) should be used to achieve positive drainage, refer to Part D "Substrate Repairs".
2. Do not proceed with sealant, mastic or coating application if surface moisture is present, or if the following conditions are anticipated:
 - a. When the dew point is within 5°F of the surface temperature.
 - b. When there is a possibility of rain.
 - c. Temperatures falling below 32°F with in a 24-hour period. Refer to specific PDS for additional guidance.

C. Cleaning

1. All surfaces to be restored must be clean, sound, dry and free of any dirt, grease, oil, debris or other contaminants which would interfere with proper adhesion. Approved cleaning methods include:
 - a. Prime-Tek Membrane Cleaner
 - b. Brooming
 - c. Power washing – a minimum working pressure of 2,000 psi is to be used.
2. Aged or new EPDM must be cleaned using Prime-Tek Membrane Cleaner and power washed.
3. Aged TPO must be cleaned using Prime-Tek Membrane Cleaner, power washed and then primed with Prime-Tek TPO primer.
4. New TPO must be primed with Prime-Tek TPO primer.
5. Aged PVC/KEE membrane must be cleaned using Prime-Tek Membrane Cleaner, power washed and then primed with Prime-Tek Bleed Block primer. Primer is only needed when using SeamlesSEAL Acrylic coatings.

Note: For cleaning/priming new PVC membrane, CRFC must be contacted for applicable requirements.

6. In low areas where contaminants may have settled, use a stiff bristled brush to ensure the surface is properly cleaned.
7. Care should be taken not to damage the roof surface or inject water into the substrate during washing.
8. Allow at least 48 hours for complete drying after the cleaning process.

D. Substrate Repairs

Prior to substrate preparation and repairs to receive the restoration coating, ensure that areas with extensive repairs (removal and replacement of wet areas, overlayment of open seams, replacement of delaminated areas, deteriorated flashing, etc.), are completed and the roof has been restored to a watertight condition.

1. At field seams that have not been repaired for the purpose of this restoration work:
 - a. Cut and remove fish mouths and loose membrane. Areas shall filled with mastic and allowed to cure.
 - b. Partially delaminated seams with delamination of 1" or less will require the removal of loose membrane and the use of mastic/sealant to fill the void.
 - c. Overlay the seams with 4-6" wide section, centered over the seam, of Reinforcing Fabric imbedded in the base coat and encapsulated in the topcoat. Refer to CRFC spec details for additional options.
2. At penetrations, field fabricated pipes, scuppers, sealant pockets, and inside and outside corners, where uncured flashing may have been used:
 - a. Encapsulate uncured flashing with a brush grade mixture of Micro Fibers and coating, extending the application onto the deck membrane approximately 2-4".
 - b. As an alternative use Reinforcing Fabric imbedded in the base coat and covered with the topcoat. The fabric must also extend horizontally 2-4" on the deck membrane.
3. Small punctures and small tears (3" or less) shall be repaired using one of the following:
 - a. After priming/reactivating with a compatible pressure sensitive overlay extending 2" in all directions. For EPDM and TPO membranes, EPDM overlay may be used. For PVC and KEE membranes PVC pressure sensitive cover strip may be used.
 - b. Use CRFC Mastic/Sealant to cover puncture areas and Reinforcing Fabric imbedded in a base coat and covered with a top coat to seal the membrane. The repair area must extend a minimum of 2" in all directions.
 - c. Use a trowel grade mixture of Micro Fiber and coating to cover punctures or tears, extending 2" beyond the damaged area.
4. At metal edging where, flashing overlay has been used, overlay the junction of the flashing on the deck side with Reinforcing Fabric (similar to field seams) centered over the splice edge and imbedded in the base coat. Use CRFC Mastic/Sealant along the edge of the overlay facing the meal edge to totally encapsulate the edge of the overlay. When applicable, prime the metal with the appropriate primer before applying the mastic. The entire overlay and Reinforcing Fabric must be covered with a final topcoat.

5. At sealant pockets, after cleaning the penetration, apply generous amount of CRFC Mastic/Sealant to encapsulate existing sealant extending the mastic up the penetration approximately 1-2"
6. All expansion joints located at deck level where the membrane is used as an expansion joint cover must be overlaid with 2 layers of Reinforcing Fabric imbedded into 2 applications of base coat and covered with one topcoat. The first layer Reinforcing Fabric must extend 4" beyond the single ply flashing and the second layer must also extend 4" beyond the first layer.
7. Flashing details must be examined for loose or deteriorated flashing, cuts, tears and open inside or outside corners. Membrane and flashing terminations should be examined at perimeters, roof penetrations and drains to ensure watertight performance. Deficient terminations should be corrected in accordance with the appropriate Carlisle published detail.
8. Minor crazing, cracking, tears or punctures may be repaired using applicable single ply technology for the specific membrane type.

Note: On TPO projects, repairs can be accomplished using either pressure sensitive EPDM or TPO where possible.

E. Final preparation before coating

Re-examine the roof to ensure the surface is clean and dry as described in Article C "Cleaning". If necessary, repeat the cleaning procedures and allow the surface to dry before coating.

1. Ensure all roof penetrations, curbs, skylights, edge metal and other roof mounted equipment are in place and secure.
2. Coordinate work with building maintenance personnel to ensure that air intake units are temporarily sealed to prevent coating overspray and fumes from entering occupied spaces.
3. Confirm that all adjacent surfaces surrounding the work area are adequately protected from overspray and frequent construction traffic.
4. Apply primer if required.

F. Coating Application and Cleanup Work

Refer to part III of the Coating Restoration Specification.

End of Attachment V

ROOF RESTORATION WITH ELASTOMERIC COATING

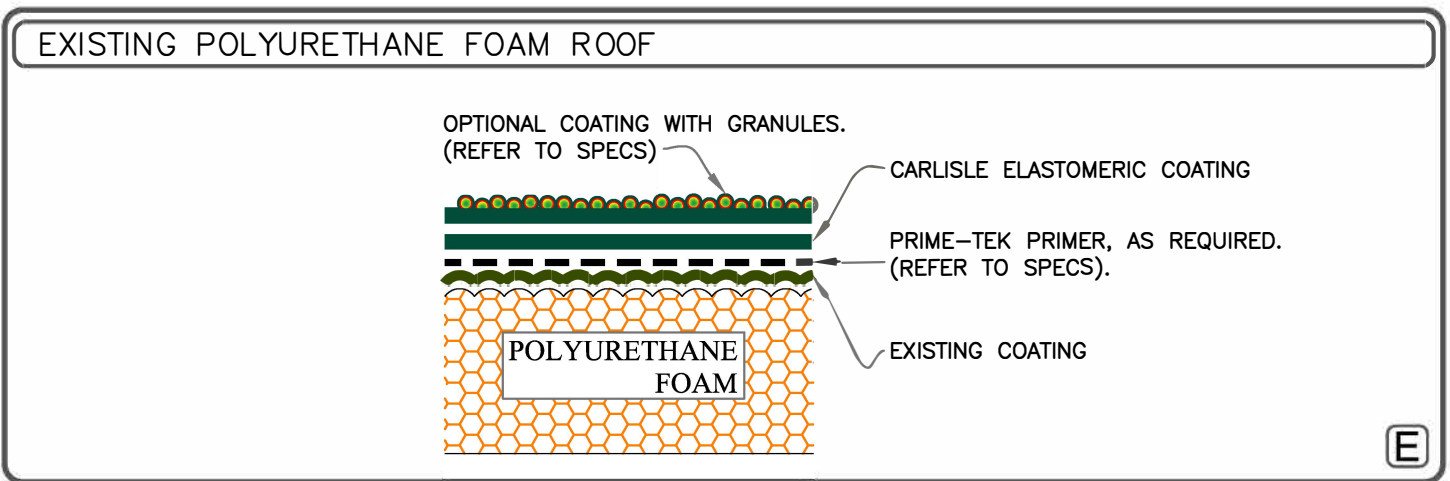
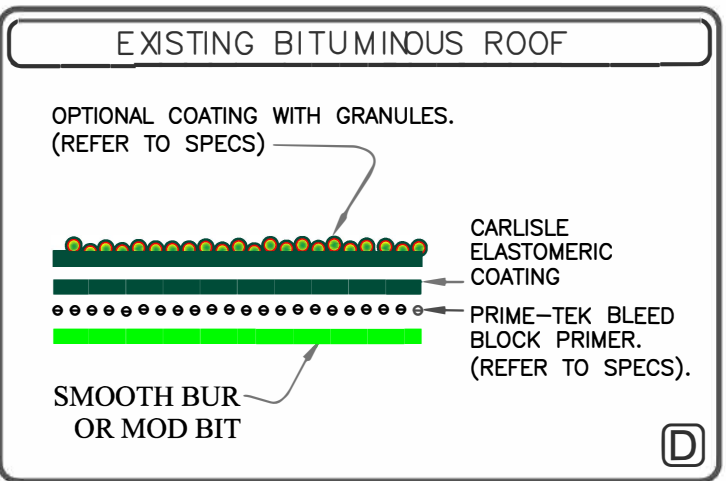
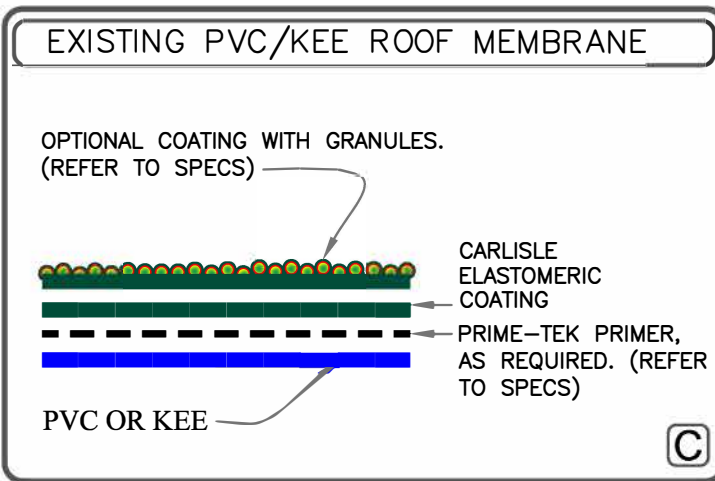
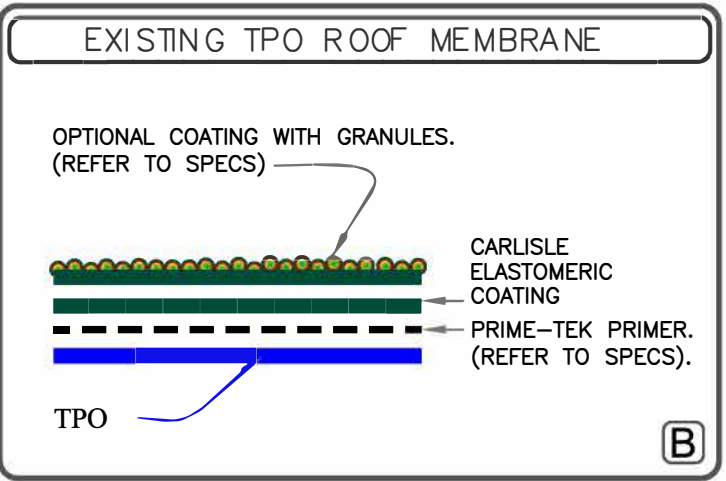
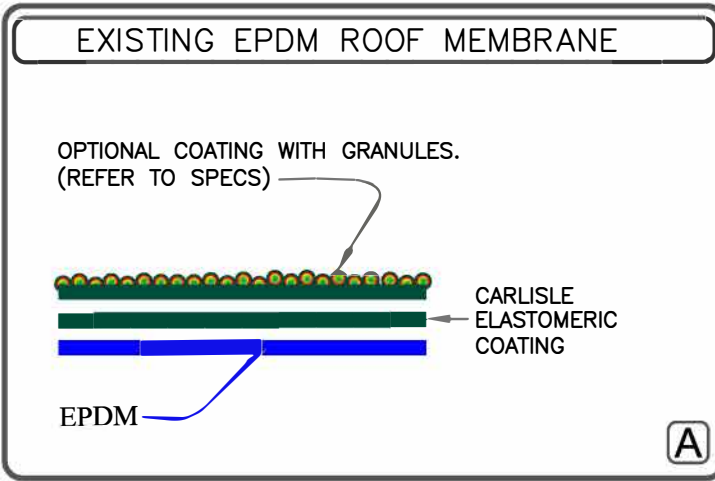

NEW COATING ON EXISTING LOW SLOPE ROOFS

		ROOF TYPES & COATING APPLICATION	A - A
NOTE(S)	CRFC SPF (SPRAY POLYURETHANE FOAM)		
CRFC PRIMER	CRFC COATING	For additional information, refer to Specifications	

ROOF RESTORATION WITH ELASTOMERIC COATING

GUIDE
NOTE

WHERE GUTTER EXISTS, TO MAINTAIN POSITIVE DRAINAGE, USE METAL DRIP EDGE WITHOUT DAM.

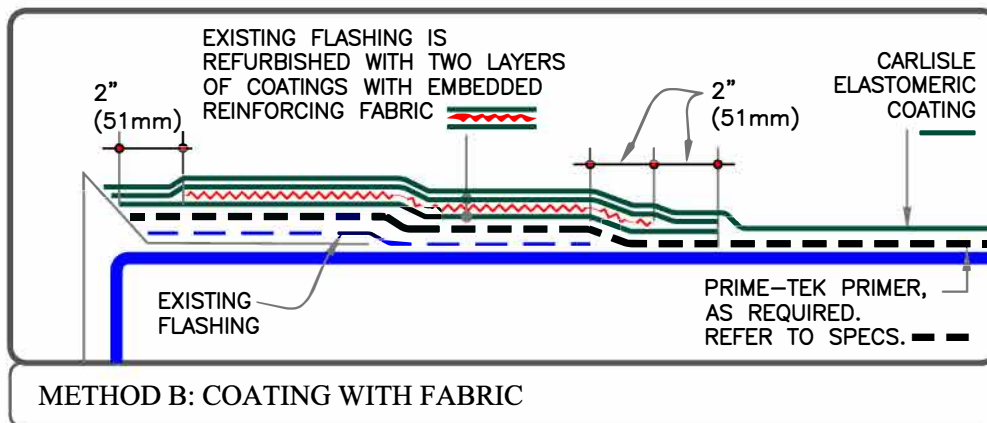
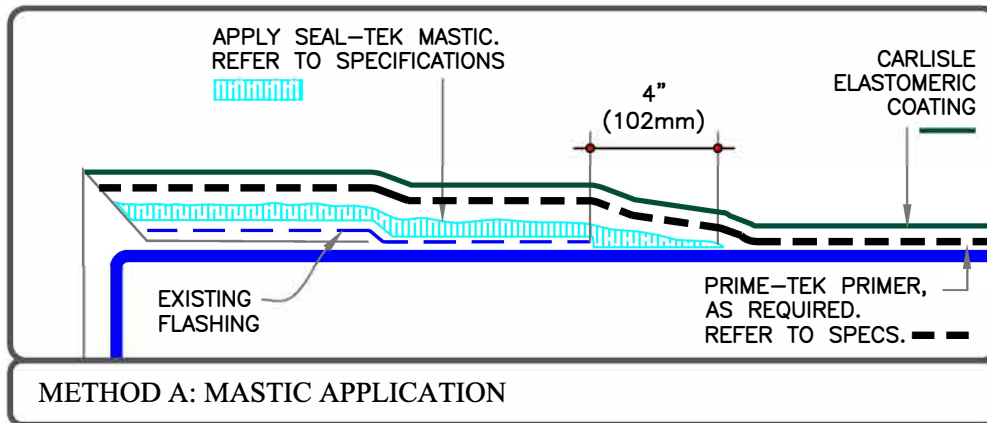
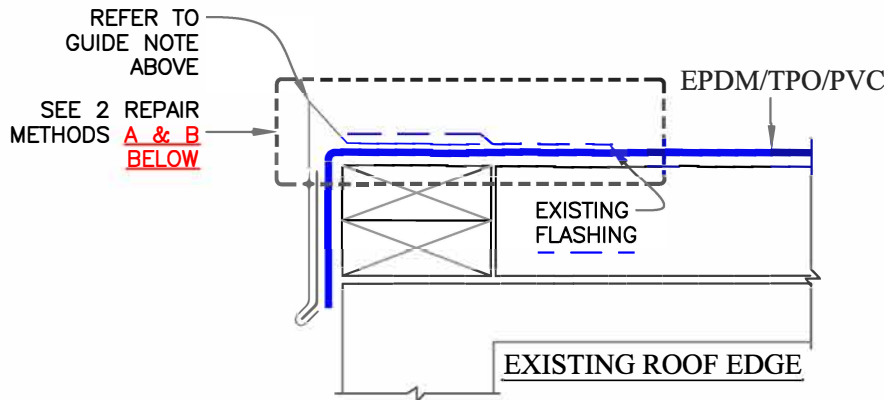

NEW COATING ON EXISTING LOW SLOPE ROOFS



METAL EDGE – EPDM/TPO/PVC ROOF:
(APPLICABLE TO GUTTER EDGE ALSO)

A-1

- 0 NOTE(S)
- CRFC PRIMER
- CRFC COATING
- CRFC SPF (SPRAY POLYURETHANE FOAM)

For additional information, refer to Specifications

ROOF RESTORATION WITH ELASTOMERIC COATING

GUIDE
NOTE

WHERE GUTTER EXISTS, TO MAINTAIN POSITIVE DRAINAGE, USE METAL DRIP EDGE WITHOUT DAM.

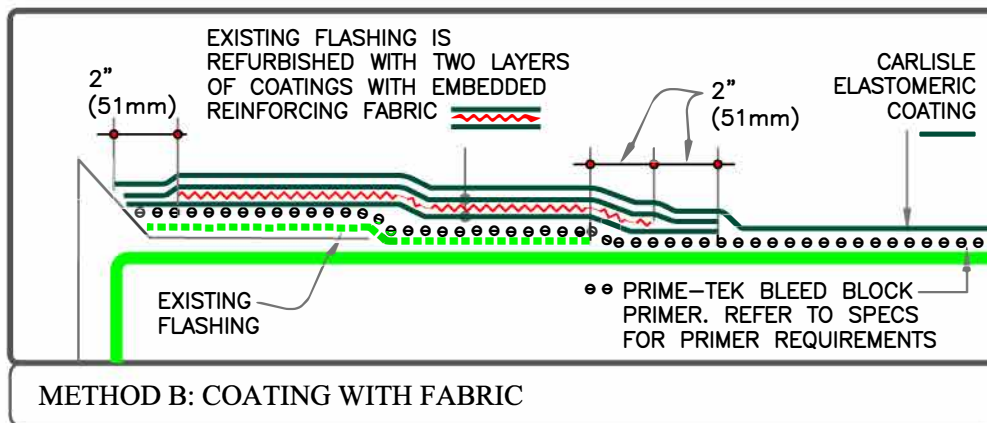
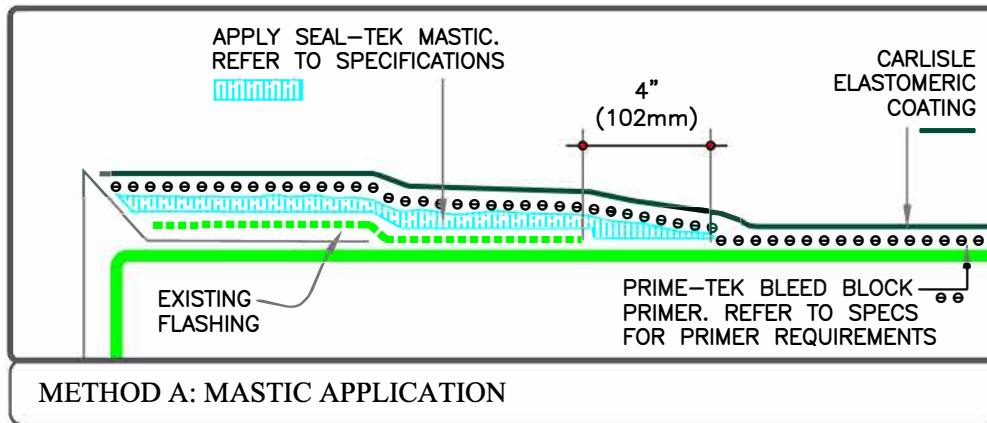
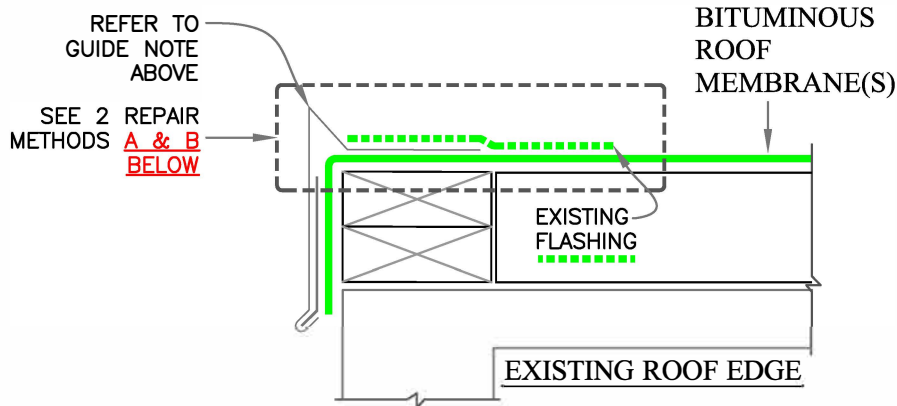

NEW COATING ON EXISTING LOW SLOPE ROOFS



METAL EDGE – BITUMINOUS ROOF:
(APPLICABLE TO GUTTER EDGE ALSO)

A-2

- 0 NOTE(S)
- CRFC SPF (SPRAY POLYURETHANE FOAM)
- CRFC PRIMER
- CRFC COATING

For additional information, refer to Specifications

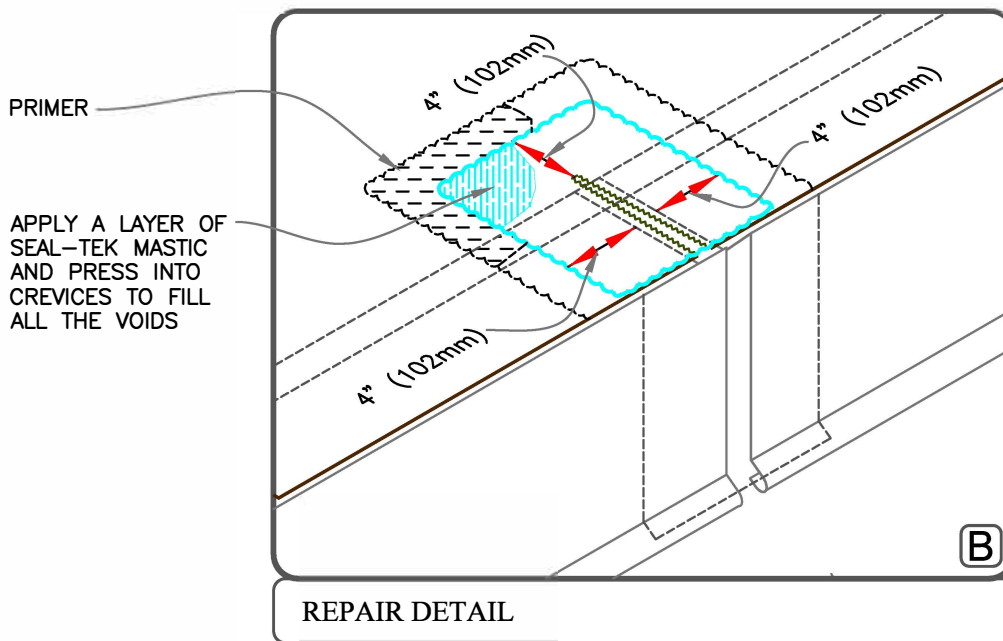
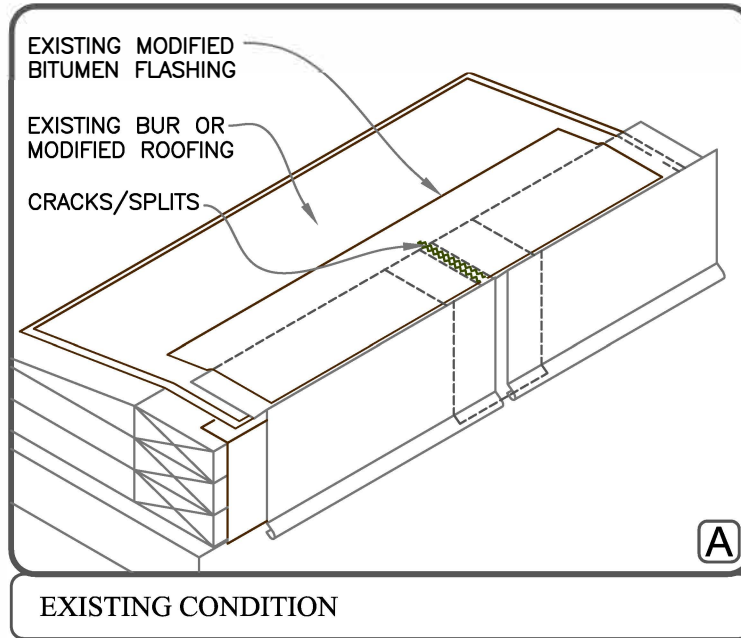

NOTE:

ENSURE, THE MASTIC IS CAREFULLY APPLIED AVOIDING THE SMEARING ON THE SHEET METAL FASCIA.

NEW COATING ON EXISTING LOW SLOPE ROOFS



REPAIR:
SPLIT FLASHING AT METAL JOINT –
BITUMINOUS ROOFS

A-3

- 0 NOTE(S)
- CRFC PRIMER
- CRFC SPF (SPRAY POLYURETHANE FOAM)
- CRFC COATING

For additional information, refer to Specifications

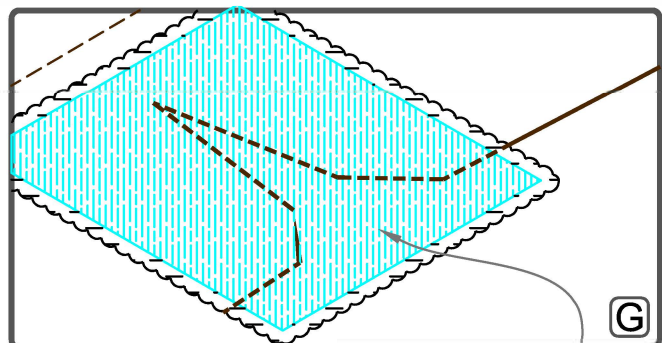
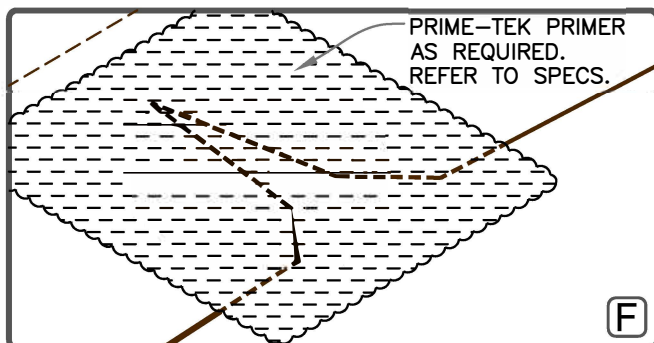
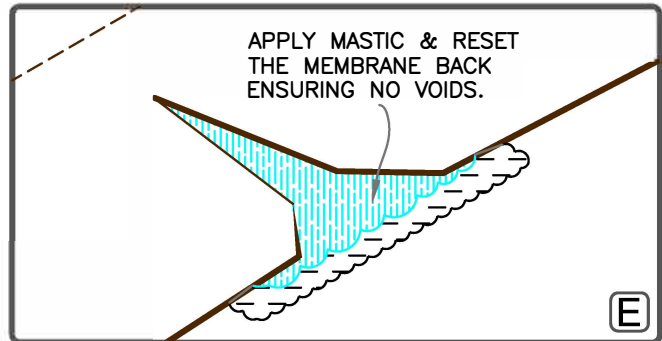
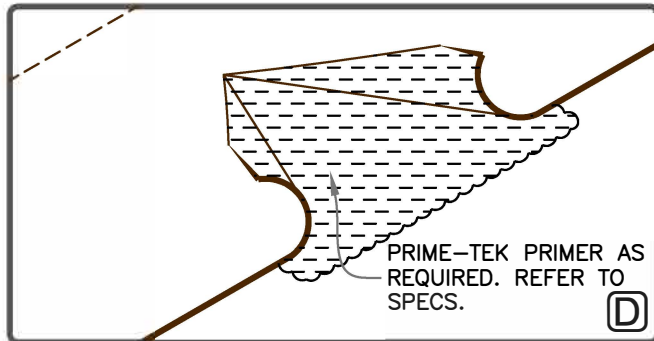
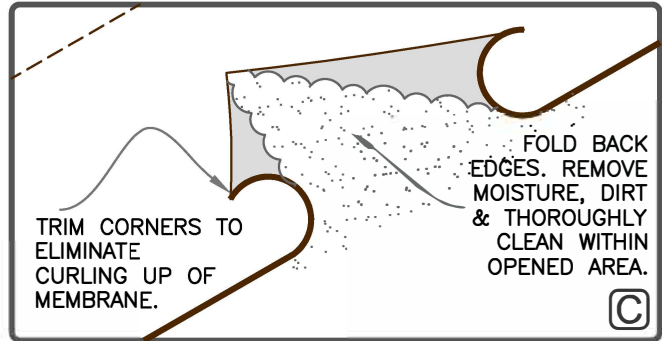
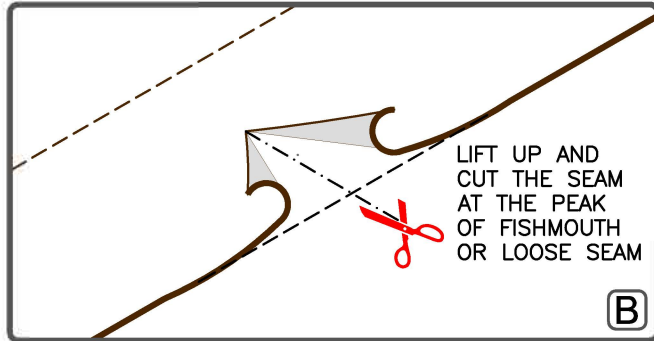
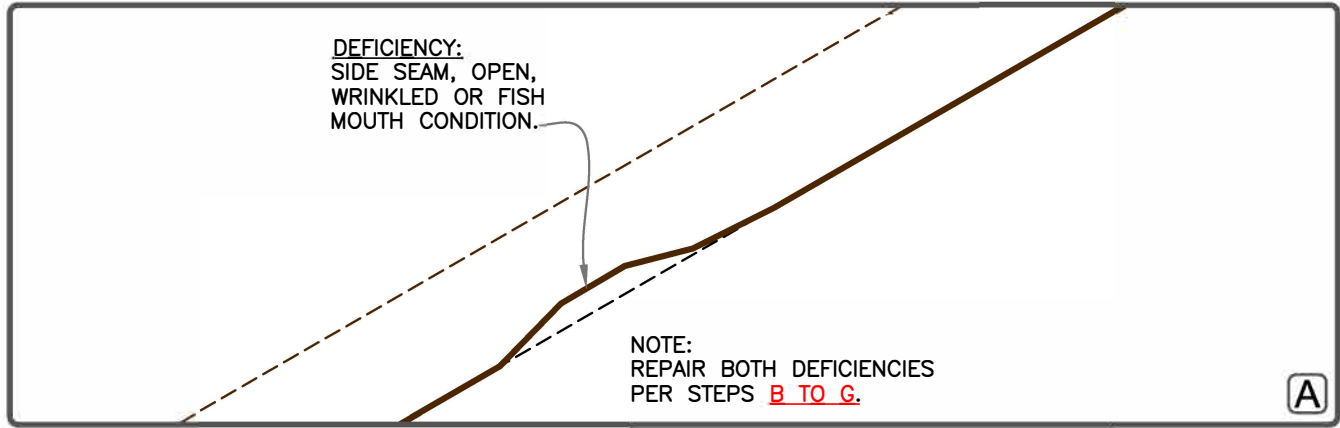

NEW COATING ON EXISTING LOW SLOPE ROOFS



REPAIR:
SEAM GAP OR WRINKLE

A-4

- O NOTE(S)
- CRFC SPF (SPRAY POLYURETHANE FOAM)
- CRFC PRIMER
- CRFC COATING

For additional information, refer to Specifications

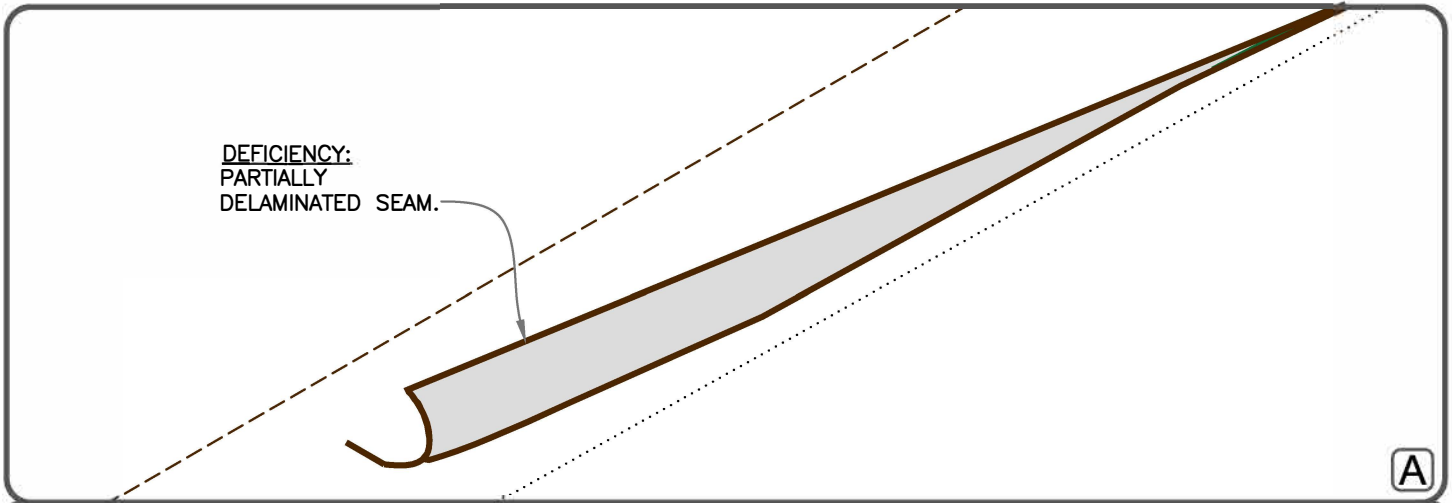

DEFICIENT SEAM - 3D VIEW

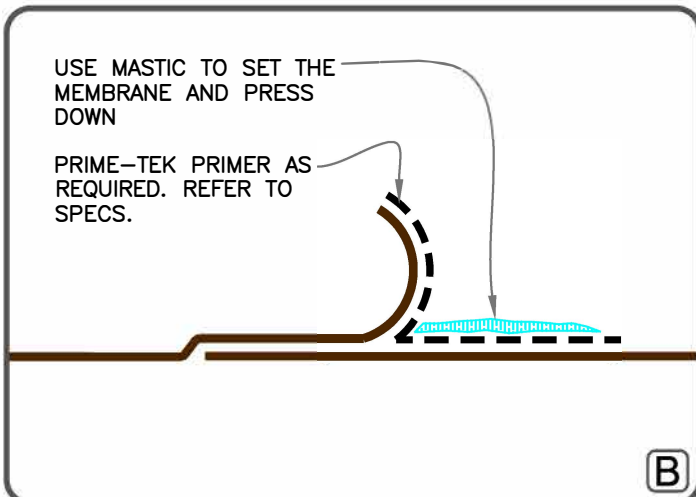

REPAIR STEP 1

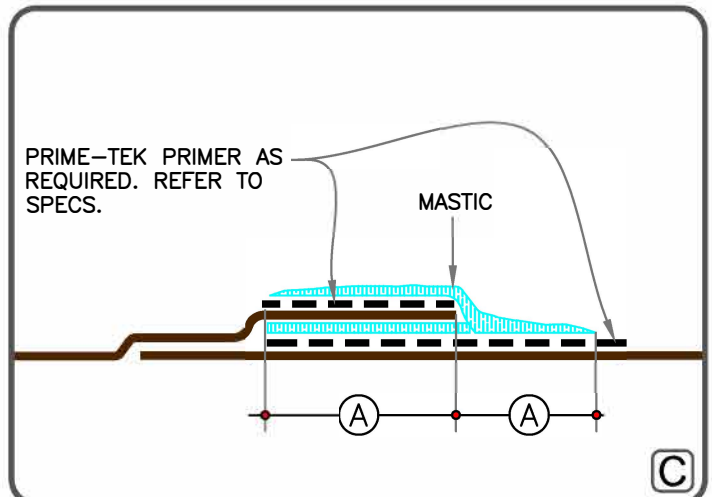

REPAIR STEP 2

DIMENSIONS		mm	
(A)	4"	102	MIN.

NEW COATING ON EXISTING LOW SLOPE ROOFS

	REPAIR: SEAM PARTIALLY DELAMINATED	A-5
	<p>NOTE(S)</p> <p>CRFC SPF (SPRAY POLYURETHANE FOAM)</p> <p>CRFC PRIMER</p> <p>CRFC COATING</p>	
For additional information, refer to Specifications		

ROOF RESTORATION WITH ELASTOMERIC COATING

NOTE: SAME DETAIL APPLIES FOR FISH MOUTHS IN THE FIELD OF ROOF

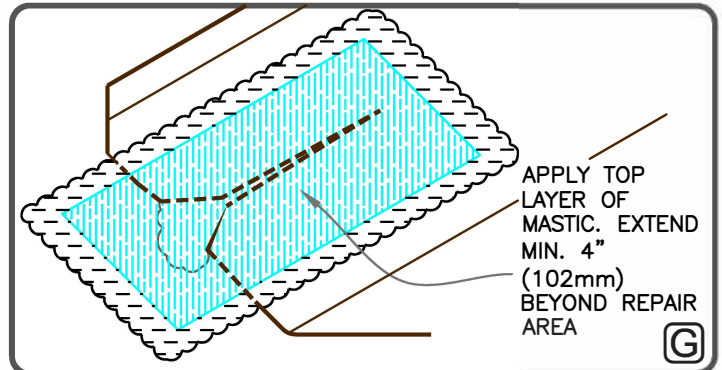
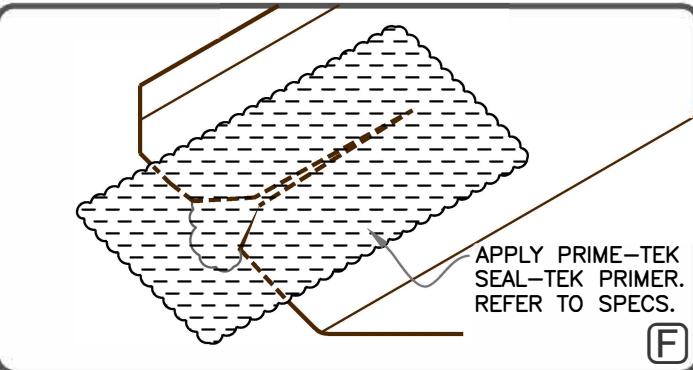
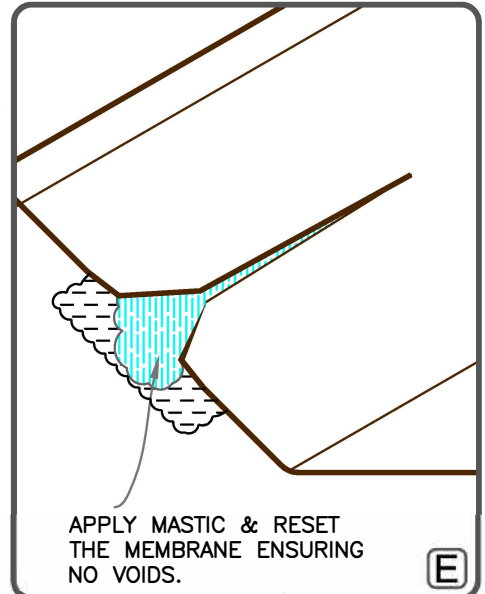
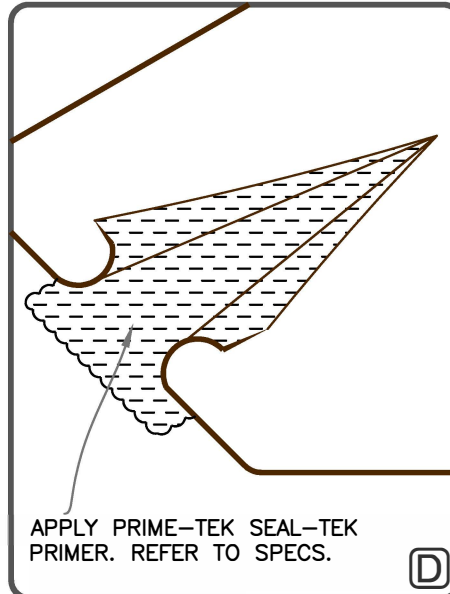
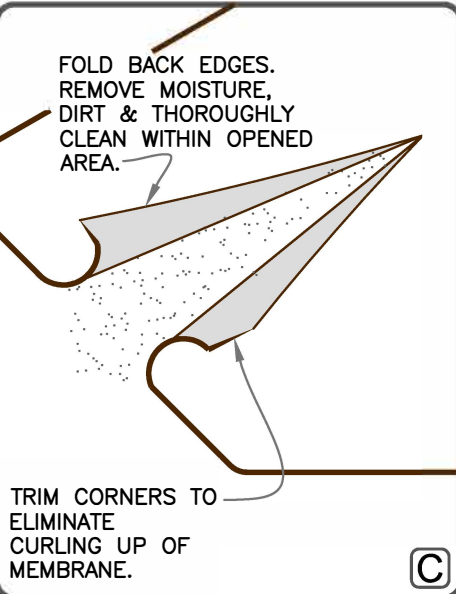
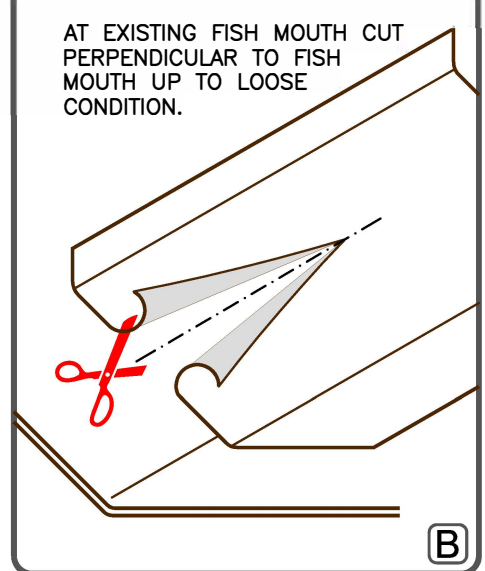
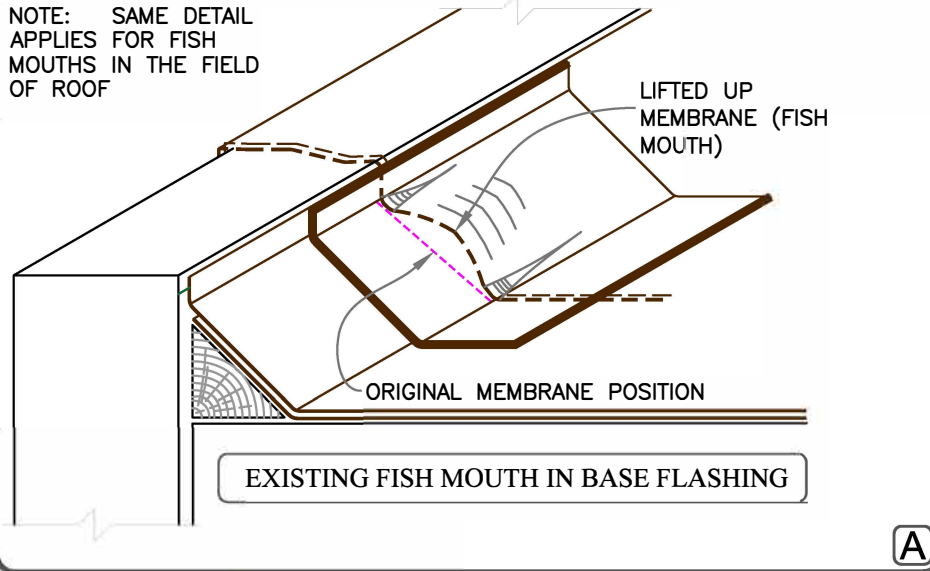

NEW COATING ON EXISTING LOW SLOPE ROOFS



- O NOTE(S)
- CRFC SPF (SPRAY POLYURETHANE FOAM)
- CRFC PRIMER
- CRFC COATING

REPAIR:
SEAM REPAIR AT DEFICIENT BASE FLASHING

For additional information, refer to Specifications

A-6

TREATMENT METHOD A

NOTES FOR A1 & A2:

1. THIS REPAIR LEVEL TO BE USED ON SEAMS WITH ACCEPTABLE CONDITIONS. FOR MORE DETERIORATED SEAMS, SEE REPAIR LEVEL 2 BELOW. THIS WILL APPLY TO ALL THE SIDE AND END LAPS.
2. THOROUGHLY CLEAN THE REPAIR AREA.
3. APPLY PRIME-TEK PRIMER AS REQUIRED. REFER TO SPECS.
4. APPLY SEAL-TEK MASTIC, EXTENDING MIN. 4" ON EACH SIDE OF SEAM.

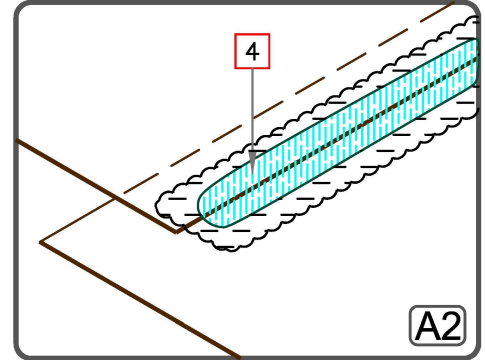
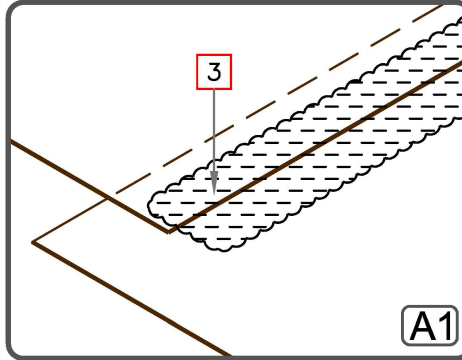

TREATMENT METHOD B

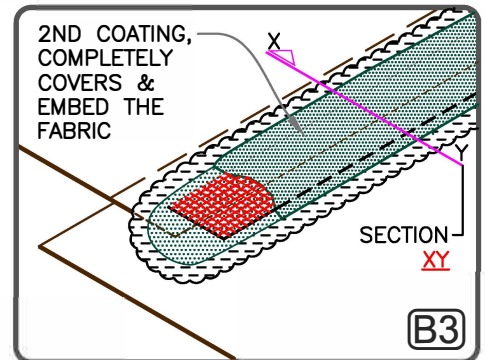
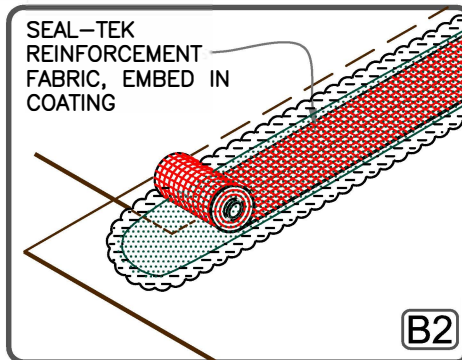
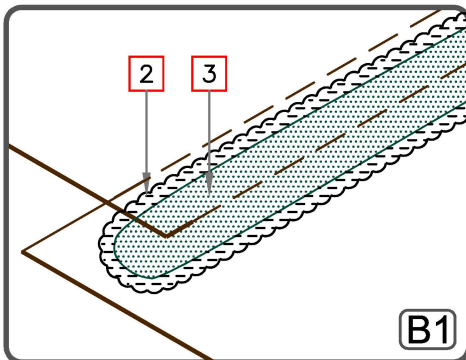

STEP B1:

STEP B2:

STEP B3:

1. THOROUGHLY CLEAN THE REPAIR AREA.
2. APPLY PRIME-TEK PRIMER AS REQUIRED. REFER TO SPECS.
3. APPLY LAYER OF COATING 2" (51mm) MIN. BEYOND THE WIDTH OF REINFORCING FABRIC.

1. IMMEDIATELY, LAY THE SEAL-TEK REINFORCEMENT FABRIC, CENTRALLY ALIGNED AT SEAM EDGE.
2. COMPLETELY SOAK AND EMBED THE FABRIC IN COATING.

1. IMMEDIATELY, APPLY A 2ND LAYER OF COATING COMPLETELY COVERING THE REINFORCEMENT FABRIC.

DIMENSIONS	mm	
(A)	2"	51 MIN.

COATING ———
 REINFORCEMENT ~~~~~
 PRIMER - - -

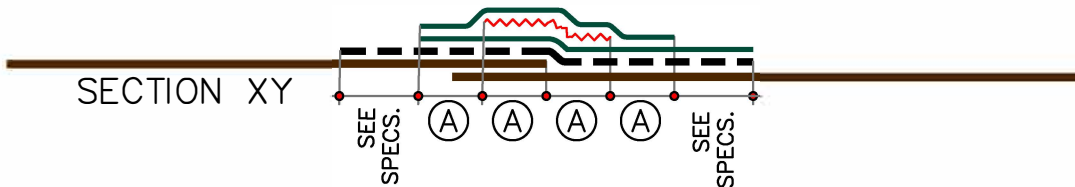

NEW COATING ON EXISTING LOW SLOPE ROOFS



FIELD SEAM TREATMENT (METHOD A & B)

A-7

- NOTE(S)
- CRFC SPF (SPRAY POLYURETHANE FOAM)
- CRFC PRIMER
- CRFC COATING

For additional information, refer to Specifications

EXISTING WRINKLED BASE FLASHING

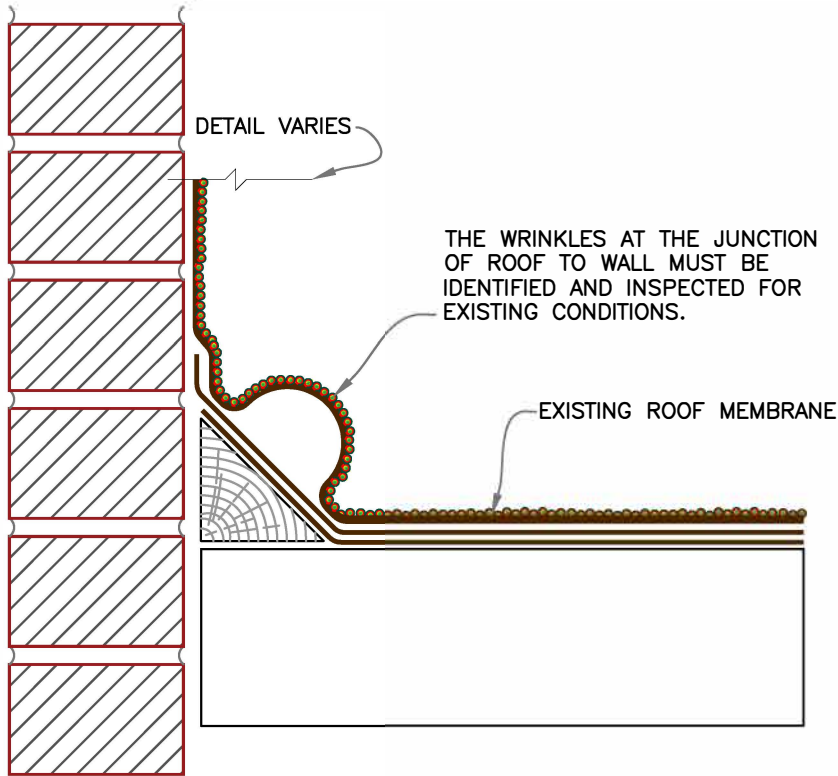

REPAIR & COATING

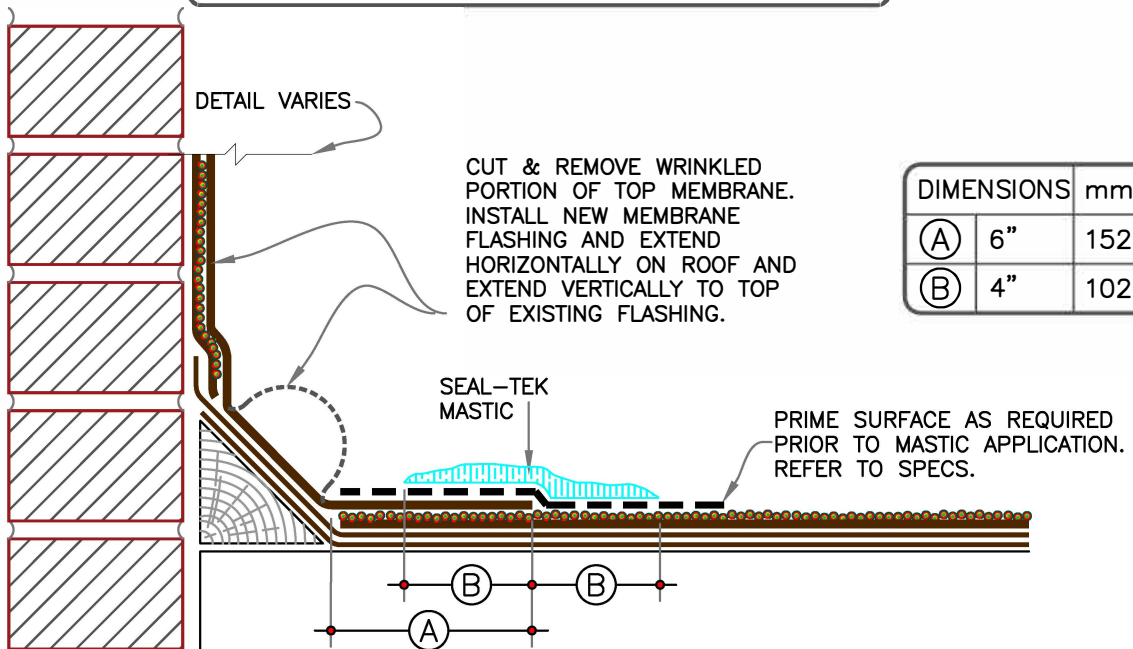

DIMENSIONS		mm	
(A)	6"	152	
(B)	4"	102	MIN.

NEW COATING ON EXISTING LOW SLOPE ROOFS



NOTE(S)

CRFC SPF (SPRAY POLYURETHANE FOAM)

CRFC PRIMER CRFC COATING

REPAIR: WRINKLES AT ROOF-TO-WALL JUNCTION

A-8

For additional information, refer to Specifications

1. IDENTIFY BLISTERS AND WRINKLES IN THE FIELD AND MARK THEM WITH PAINT OR CRAYON.
2. MAKE A CROSS CUT WITHIN BLISTERED SURFACE & LIFT UP THE EDGES TO RELEASE THE AIR & MOISTURE. TRIM EDGES AS NEEDED.
3. REMOVE DEBRIS AND THOROUGHLY CLEAN THE BLISTERED AREA. ENSURE SURFACE IS DRY. PRIME SURFACES AS REQUIRED, REFER TO SPECS.
4. APPLY SEAL-TEK MASTIC WITHIN THE CUT AREA. PUSH MASTIC UNDER THE LIFTED EDGES AND COMPLETELY EMBED ALL FOUR EDGES.

A

RESET MEMBRANE IN MASTIC

COVER WITH TROWEL-GRADE SEAL-TEK MASTIC EXTENDING 4" (102mm) BEYOND ALL CUTS IN MEMBRANE.

B

NEW COATING ON EXISTING LOW SLOPE ROOFS

	<p>REPAIR – METHOD A (MASTIC): BLISTERS / WRINKLES</p>	<p>A-9</p>
<p>0 NOTE(S) CRFC SPF (SPRAY POLYURETHANE FOAM)</p> <p> CRFC PRIMER CRFC COATING</p>	<p>For additional information, refer to Specifications</p>	

1. IDENTIFY BLISTERS AND WRINKLES IN THE FIELD AND MARK THEM WITH PAINT OR CRAYON.
2. MAKE A CROSS CUT WITHIN BLISTERED SURFACE & LIFT UP THE EDGES TO RELEASE THE AIR & MOISTURE. TRIM EDGES AS NEEDED.
3. REMOVE DEBRIS AND THOROUGHLY CLEAN THE BLISTERED AREA. ENSURE SURFACE IS DRY. PRIME SURFACES AS REQUIRED, REFER TO SPECS.
4. APPLY SEAL-TEK MASTIC WITHIN THE CUT AREA. PUSH MASTIC UNDER THE LIFTED EDGES AND COMPLETELY EMBED ALL FOUR EDGES.

A

5. RESET MEMBRANE IN MASTIC
6. CUT REINFORCEMENT FABRIC TO COVER THE AREA. FABRIC SHALL EXTEND MIN. 2" (51mm) BEYOND THE CROSS-CUT LIMITS.
7. APPLY LAYER OF COATING MIN. 2" (51mm) BEYOND THE DIMENSIONS OF PRE-CUT REINFORCEMENT FABRIC.

B

8. LAY THE PRE-CUT REINFORCEMENT FABRIC, CENTRALLY ALIGNED OVER BLISTER REPAIR. EMBED FABRIC IN BOTTOM COATING.
9. APPLY THE UPPER COATING A MIN. 2" (51mm) BEYOND THE WIDTH OF REINFORCING FABRIC.

C

NEW COATING ON EXISTING LOW SLOPE ROOFS



REPAIR – METHOD B:
(REINFORCING FABRIC) BLISTERS/WRINKLES

A-10

- 0 NOTE(S)
- CRFC SPF (SPRAY POLYURETHANE FOAM)
- CRFC PRIMER
- CRFC COATING

For additional information, refer to Specifications

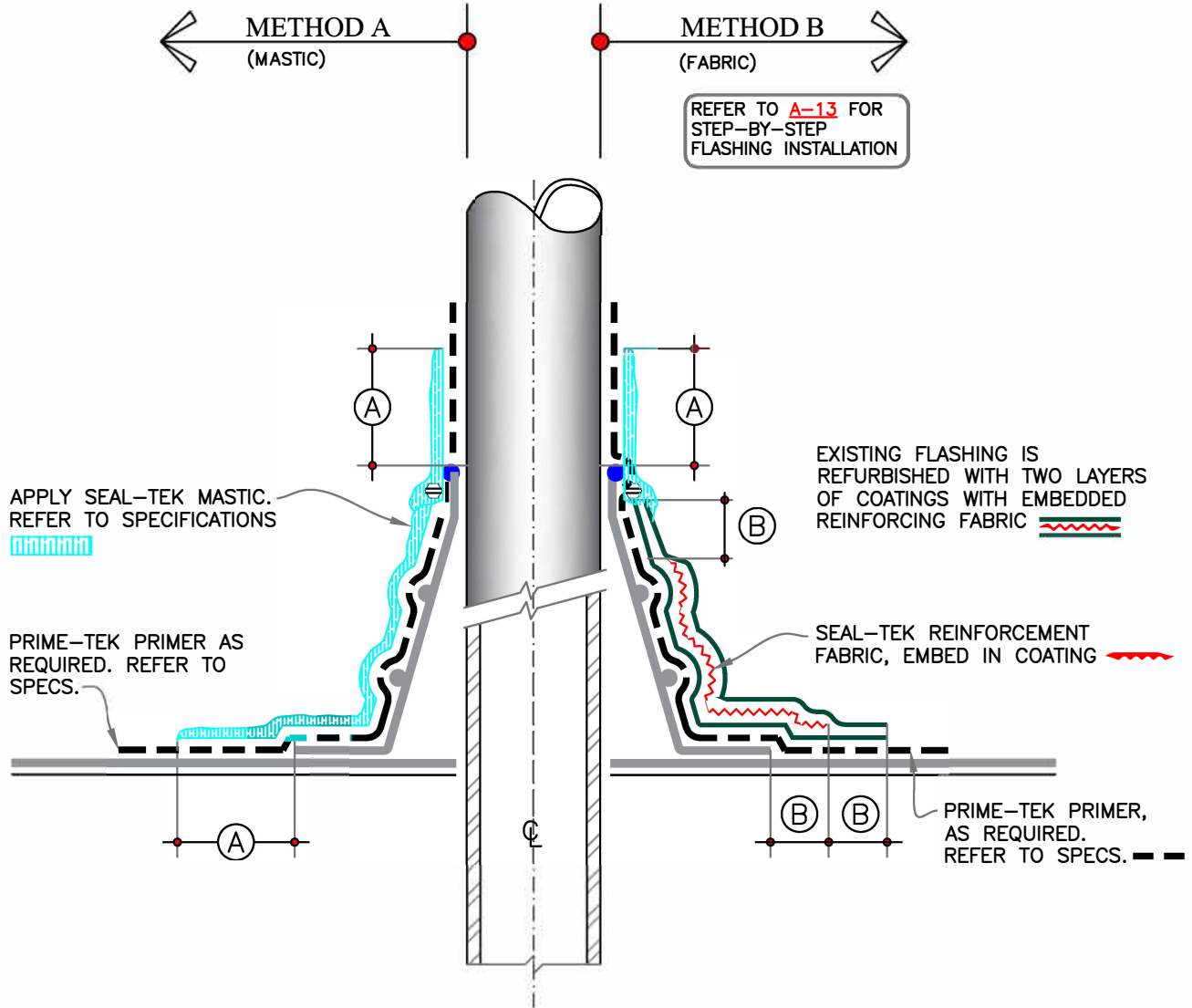

DIMENSIONS		mm	
(A)	4"	102	MIN.
(B)	2"	51	MIN.

NEW COATING ON EXISTING LOW SLOPE ROOFS



TREATMENT OF PRE-MOLDED PIPE/TUBING FLASHING

A-11

- O NOTE(S)
- CRFC SPF (SPRAY POLYURETHANE FOAM)
- CRFC PRIMER
- CRFC COATING

For additional information, refer to Specifications

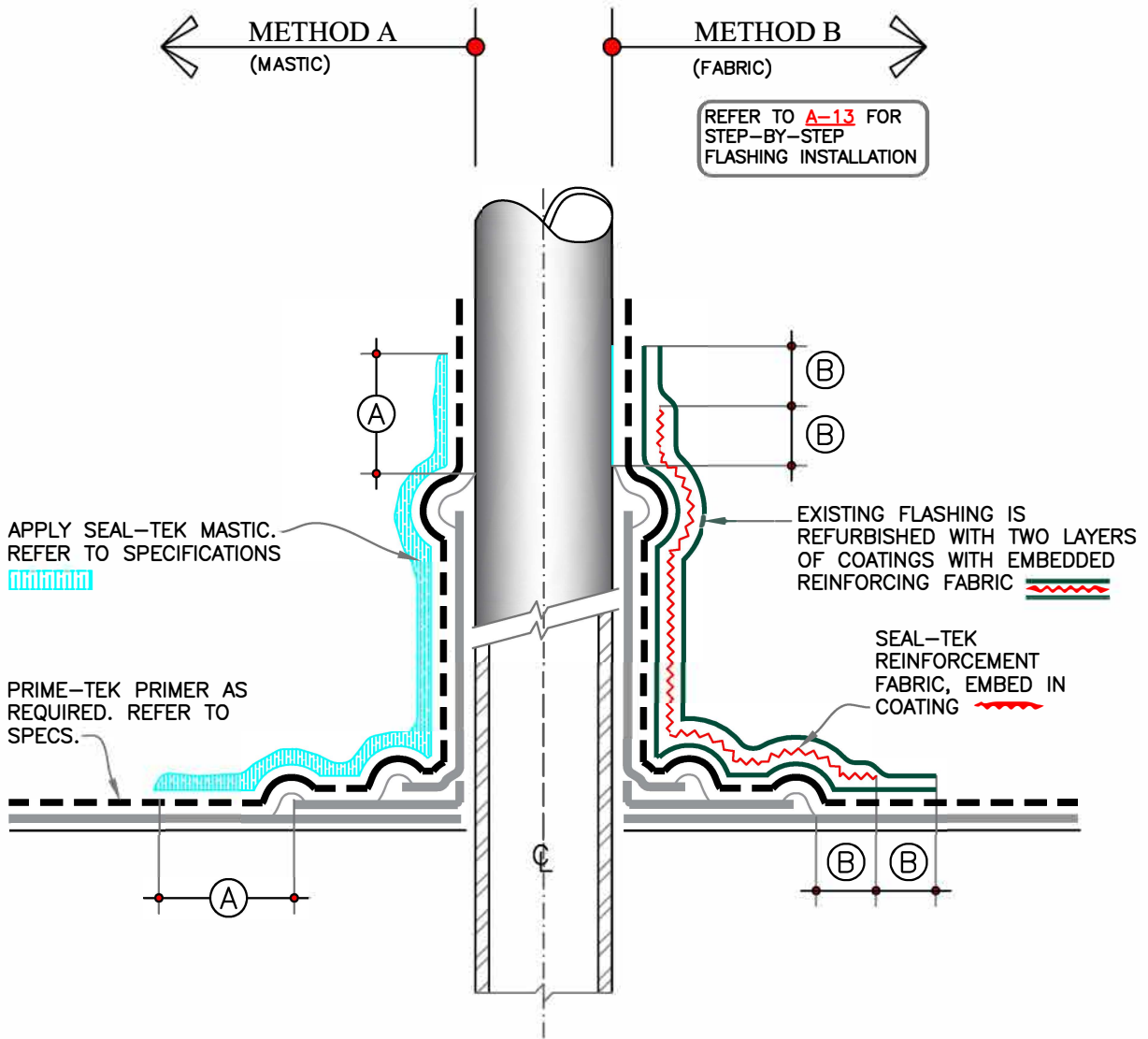

DIMENSIONS	mm	
(A)	4"	102 MIN.
(B)	2"	51 MIN.

NEW COATING ON EXISTING LOW SLOPE ROOFS



TREATMENT OF FIELD FABRICATED PIPE/TUBING FLASHING

A-12

- O NOTE(S)
- CRFC SPF (SPRAY POLYURETHANE FOAM)
- CRFC PRIMER
- CRFC COATING

For additional information, refer to Specifications

ROOF RESTORATION WITH ELASTOMERIC COATING

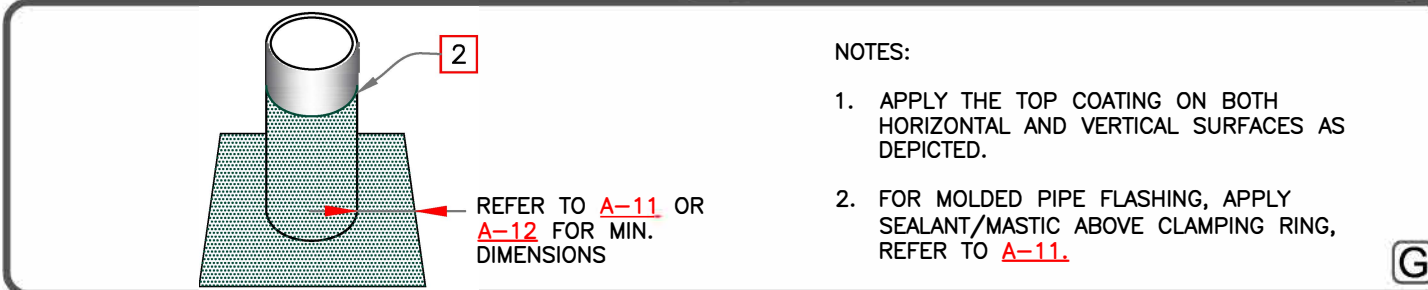
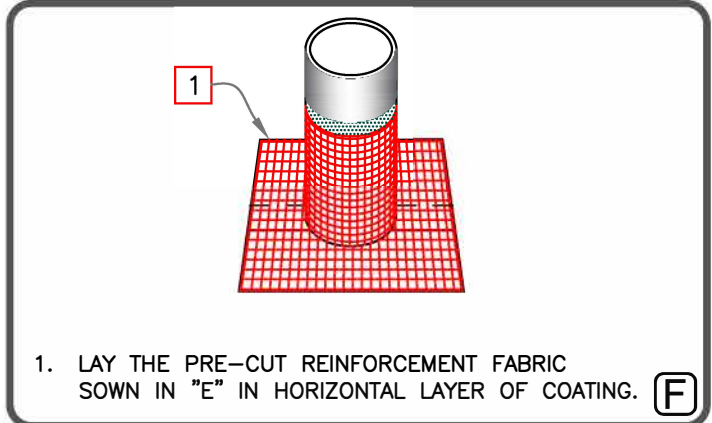
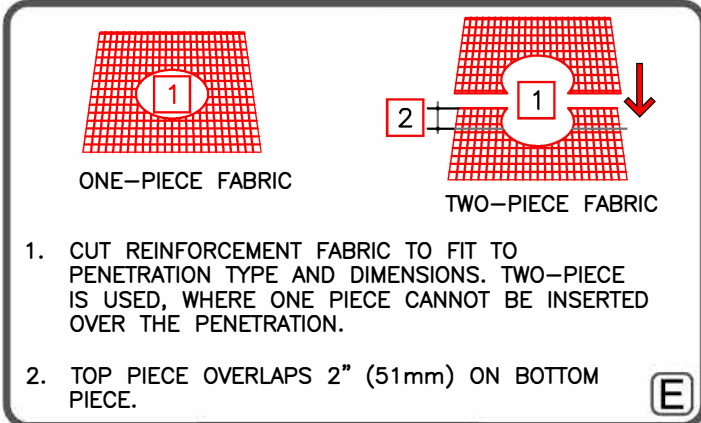
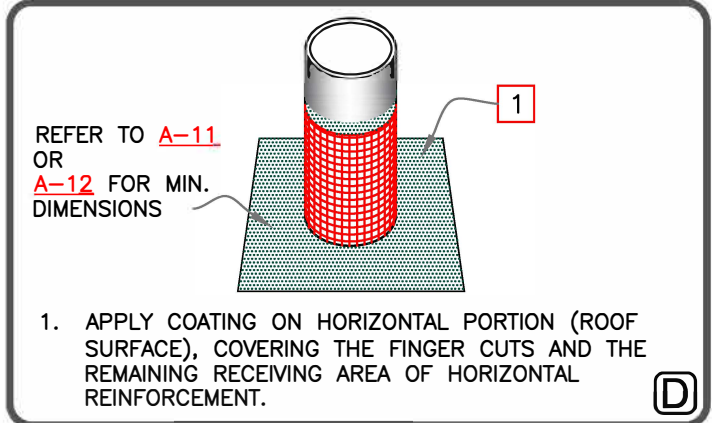
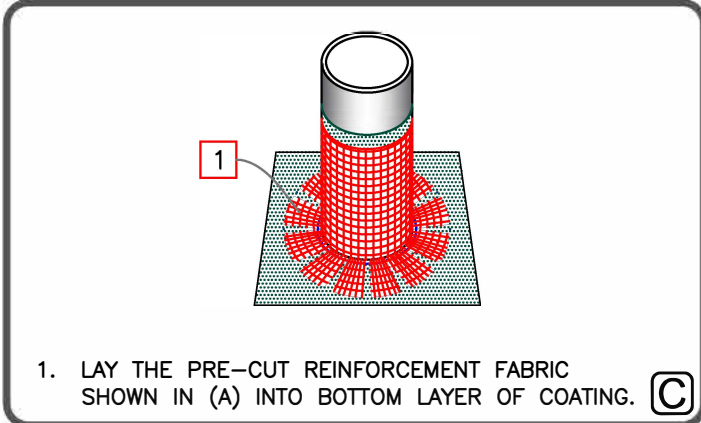
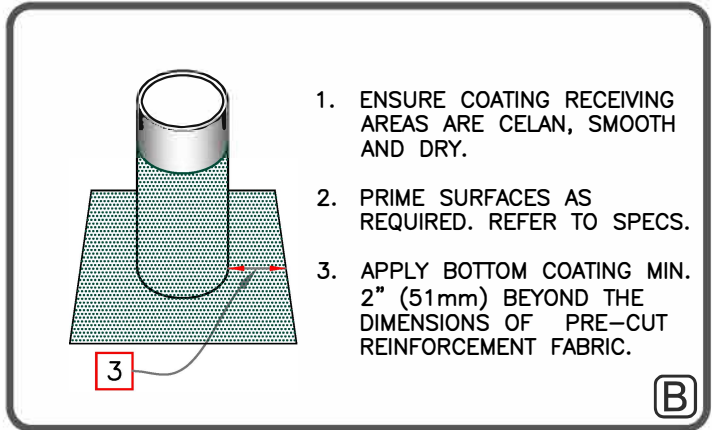
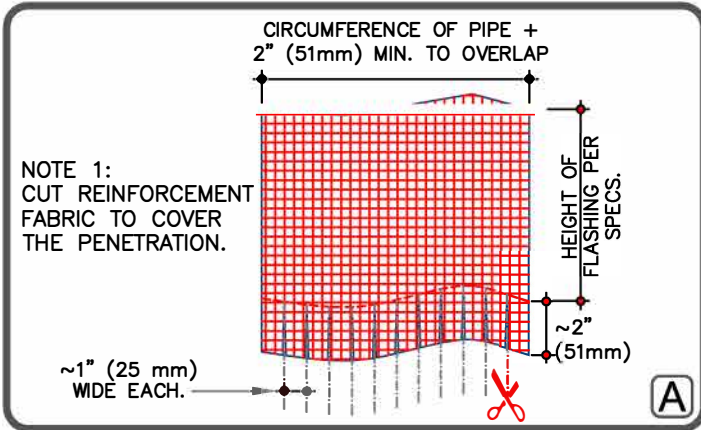

NEW COATING ON EXISTING LOW SLOPE ROOFS



METHOD B: STEP-BY-STEP FLASHING WITH REINFORCEMENT FABRIC & COATING

A-13

- 0 NOTE(S)
- CRFC SPF (SPRAY POLYURETHANE FOAM)
- CRFC PRIMER
- CRFC COATING

For additional information, refer to Specifications

A: 3D VIEW OF TYPICAL METAL ROOF

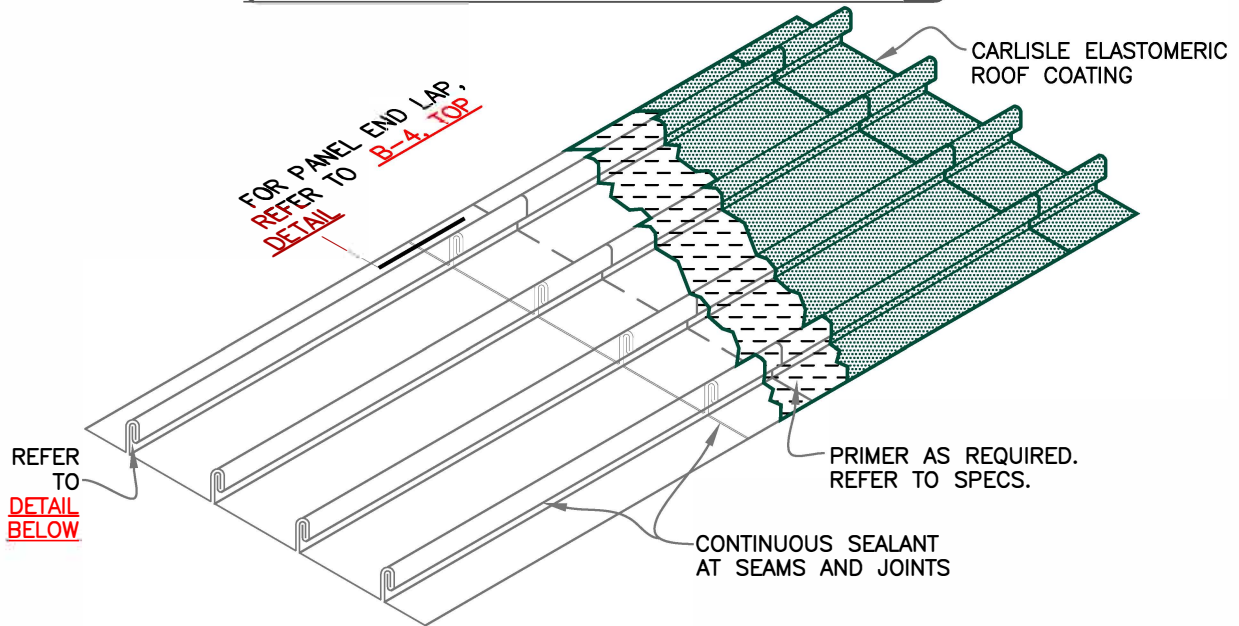

B: COATING DETAIL AT STANDING SEAM

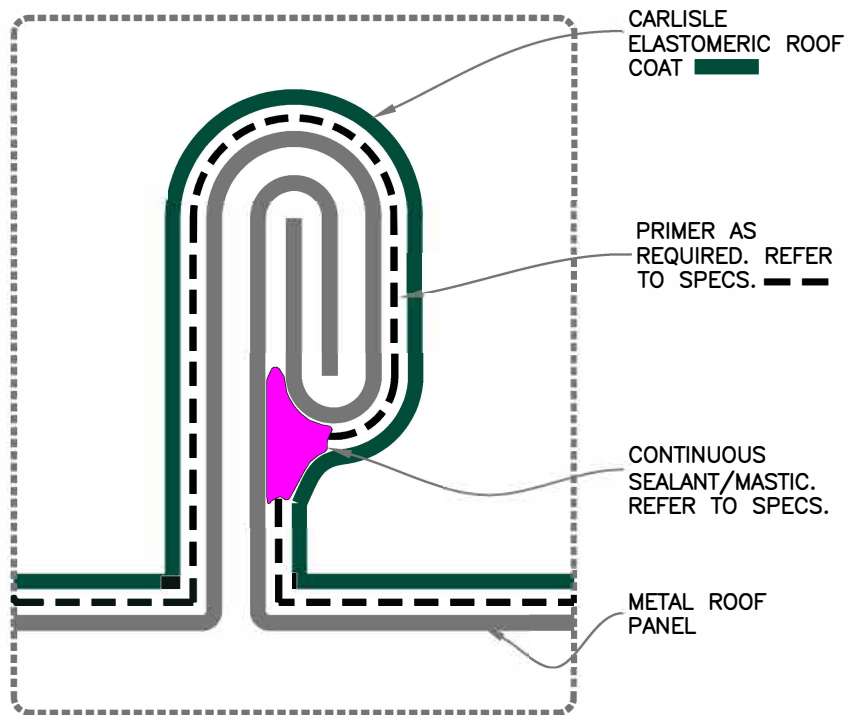

NOTE:

THIS IS A REFERENCE DETAIL DEPICTING A GENERIC STANDING SEAM OF METAL ROOF AND HOW TO TREAT IT PRIOR TO COATING PROCESS. SAME APPLIES TO OTHER SIMILAR SEAMS WITH DIFFERENT PROFILES SHOWN ON B-2

NEW COATING ON EXISTING METAL ROOFS



STANDING SEAM METAL ROOF COATING

B-1

- 0 NOTE(S)
- CRFC SPF (SPRAY POLYURETHANE FOAM)
- CRFC PRIMER
- CRFC COATING

For additional information, refer to Specifications

ROOF RESTORATION WITH ELASTOMERIC COATING

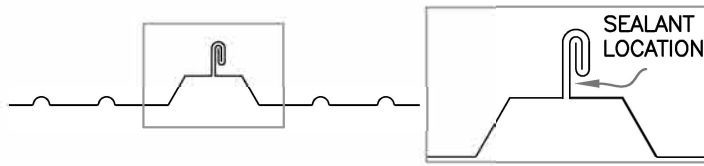

A TRAPEZOIDAL STANDING SEAM

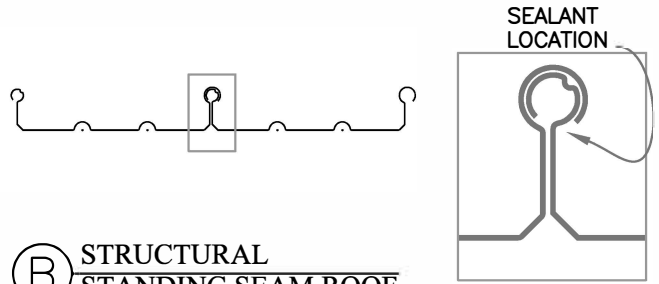

B STRUCTURAL STANDING SEAM ROOF

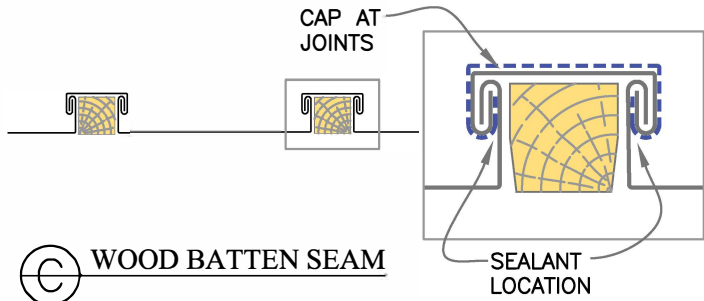

C WOOD BATTEN SEAM

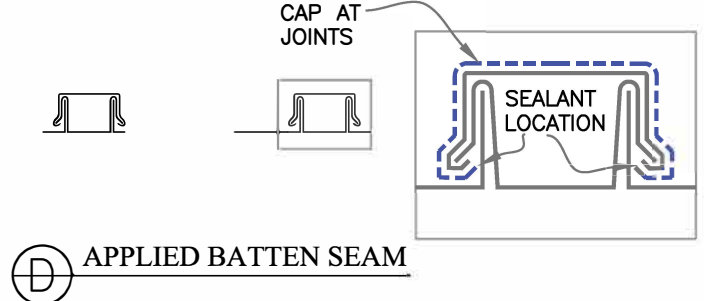

D APPLIED BATTEN SEAM

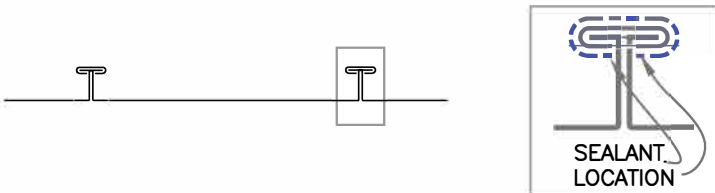

E TEE / CAPPED SEAM

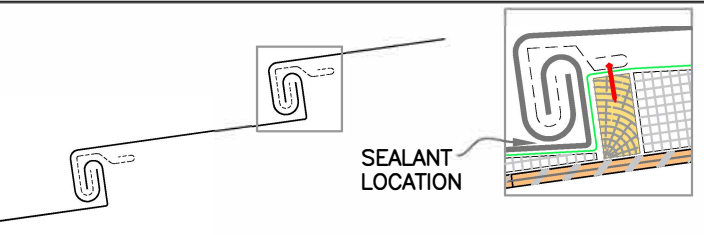

F BERMUDA TYPE ROOF (HORIZONTAL SEAMS)

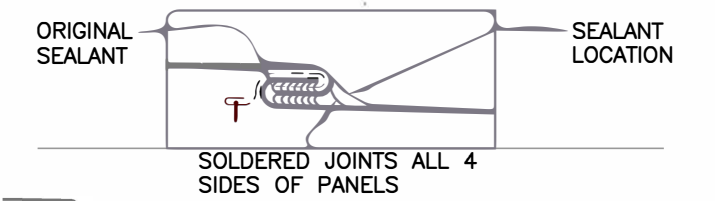

G LOW-SLOPE (FLAT) COPPER ROOF

NOTE:

FOR ADDITIONAL PROFILES, CONTACT CRFC (CARLISLE ROOF FOAM AND COATING)

NEW COATING ON EXISTING METAL ROOFS



METAL ROOF: SEAM TREATMENT OF VARIOUS PROFILES

B-2

- 0 NOTE(S)
- CRFC SPF (SPRAY POLYURETHANE FOAM)
- CRFC PRIMER
- CRFC COATING

For additional information, refer to Specifications

DETAIL LOCATIONS

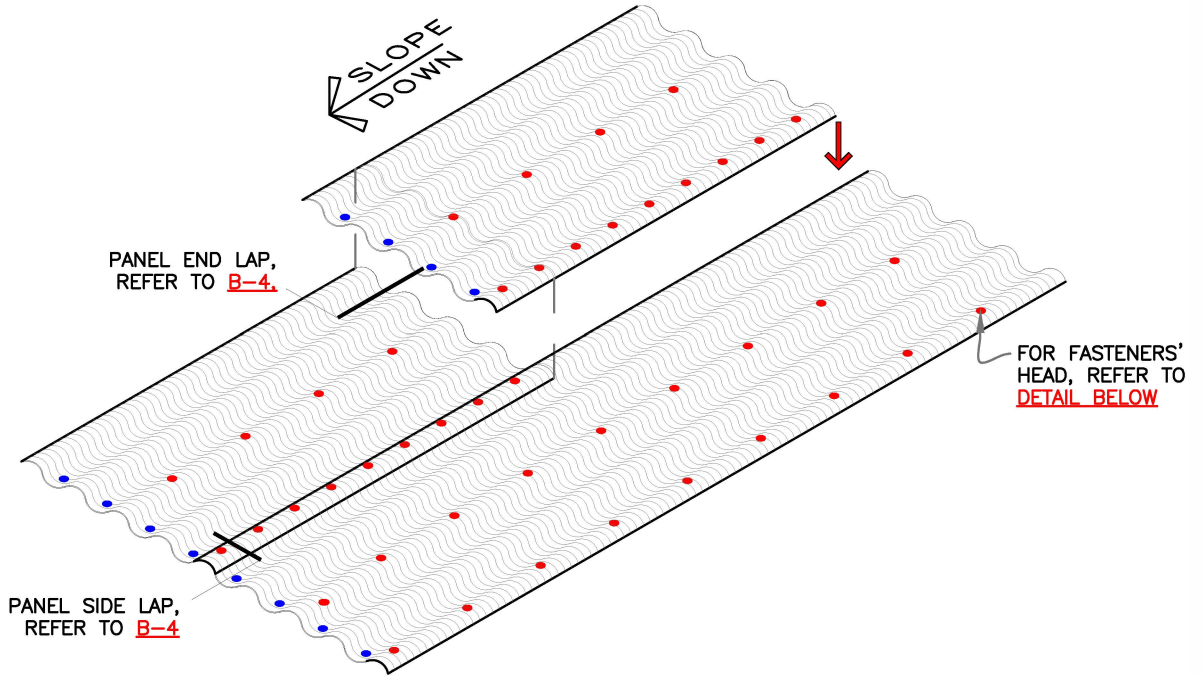

FASTENER HEAD TREATMENT PRIOR TO COATING

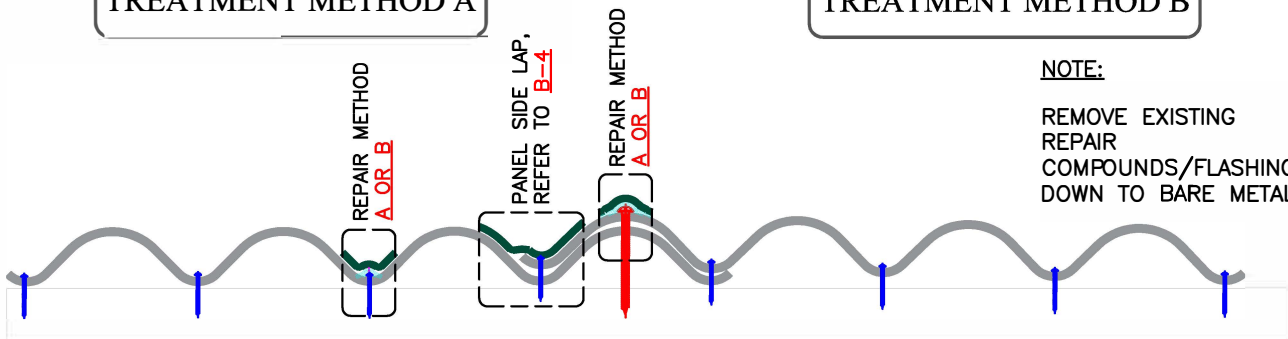
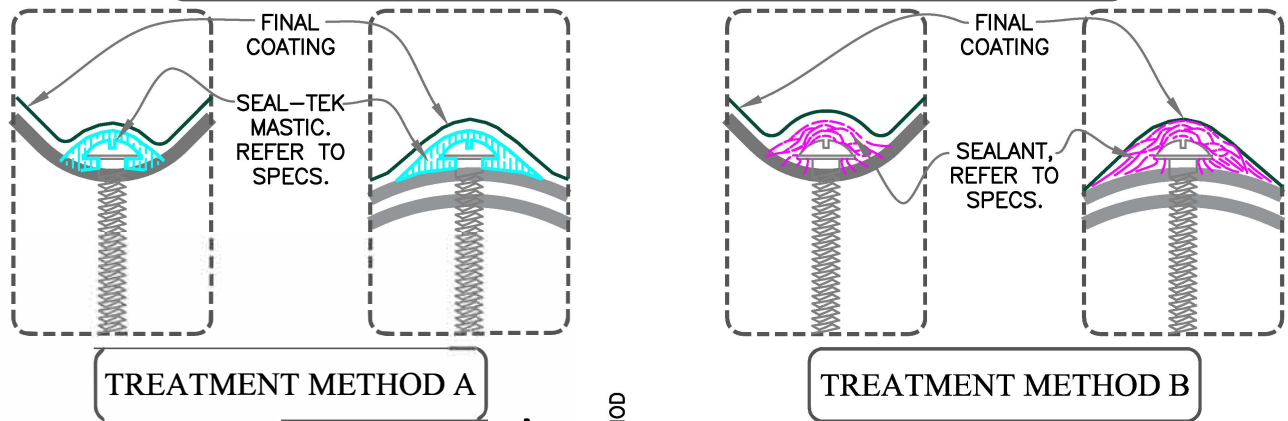

NEW COATING ON EXISTING METAL ROOFS



TREATMENT OF EXPOSED FASTENERS

B-3

- 0 NOTE(S)
- CRFC SPF (SPRAY POLYURETHANE FOAM)
- CRFC PRIMER
- CRFC COATING

For additional information, refer to Specifications

PANEL END-LAP

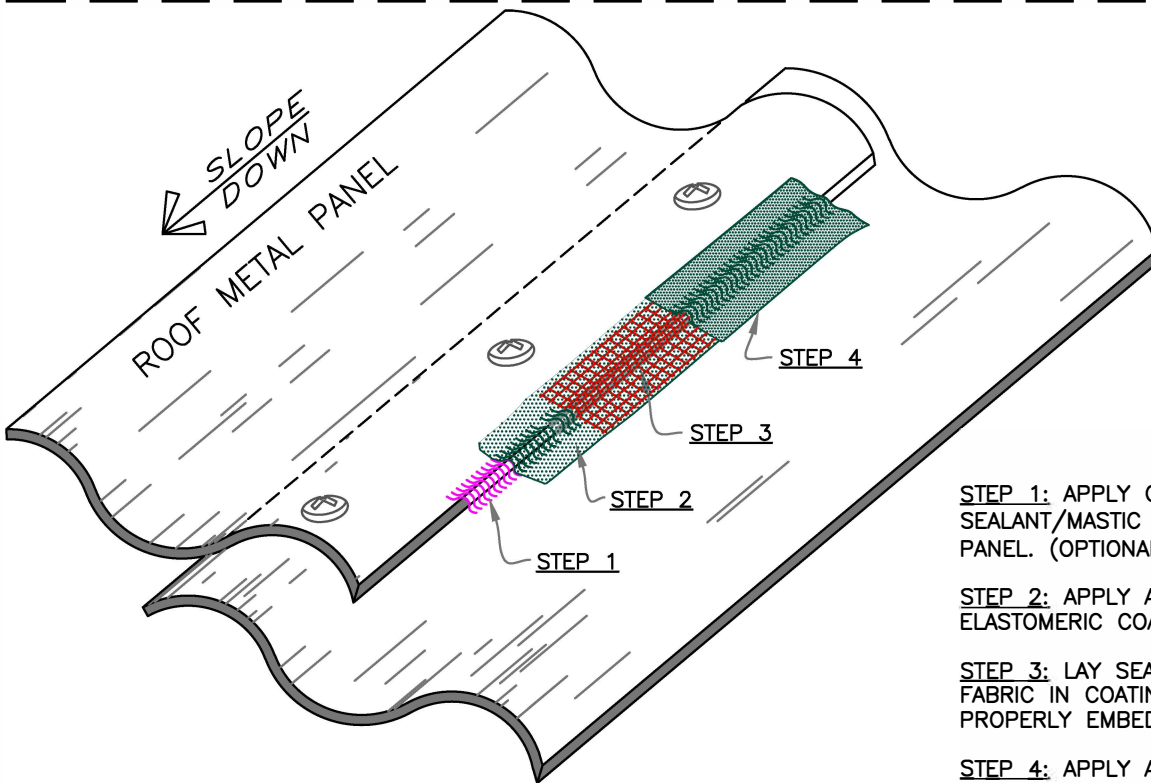
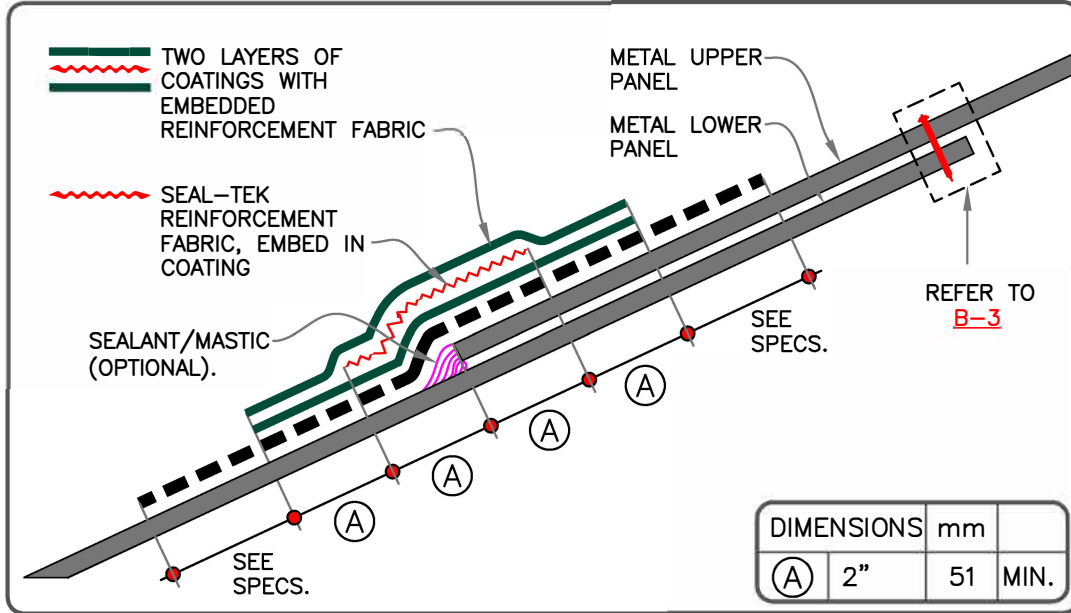

STEP 1: APPLY CONTINUOUS SEALANT/MASTIC ALONG THE EDGE OF PANEL. (OPTIONAL).

STEP 2: APPLY A LAYER OF CARLISLE ELASTOMERIC COATING.

STEP 3: LAY SEAL-TEK REINFORCEMENT FABRIC IN COATING. ENSURE FABRIC IS PROPERLY EMBEDDED IN THE COATING.

STEP 4: APPLY A 2ND LAYER OF COATING COVERING THE SEAL-TEK REINFORCEMENT FABRIC AND SLIGHTLY EXTEND BEYOND THE BOTTOM COATING.

PANEL SIDE LAP

REFER TO DETAIL ABOVE FOR DIMENSIONS

NEW COATING ON EXISTING METAL ROOFS



PANELS END LAP & SIDE LAP DETAILS

B-4

NOTE(S)

CRFC SPF (SPRAY POLYURETHANE FOAM)

CRFC PRIMER CRFC COATING

For additional information, refer to Specifications



Table of Contents

October 2019

Reference

Wood Nailer and Securement Criteria.....	DR-01-19
Metal Edging & Coping.....	DR-02-19
Moisture in Concrete.....	DR-03-19



D-01-19

Wood Nailers and Securement Criteria (Factory Mutual Loss Prevention Data Sheet 1-49)

October 2019

The information contained in this supplement serves as a criteria for Specifiers and Authorized Applicators regarding the design and installation of Carlisle Roof Foam and Coatings (CRFC) roofing systems and related products. Additional information essential for the design and installation of the Roof Systems are also included in the respective Specification for each Roof System and in the Design Reference Section of as well as the applicable Spec Supplement.

One of the most often overlooked details on a roofing system is the attachment method for wood nailers at the perimeter of the roof. Factory Mutual Global (FMG) publishes design recommendations for the attachment of wood nailers to various substrates and for the attachment of perimeter flashing details to wood nailers. This information is contained in Factory Mutual's Property Loss Prevention Data Sheet 1-49. In accordance with that Data Sheet, the information listed below should be referenced when selecting an appropriate perimeter attachment method.

General Criteria

A **horizontal wood nailer** is used to provide an effective substrate for some installation details and for other roof accessories. In addition, it is used to provide solid protection for the edge of the roof assembly. Minimum thickness of the nailer must be thick enough that the top of the nailer is flush with the top of the roof assembly.

1. The width of the nailers must exceed the width of the metal flange of edgings, scuppers, etc.
2. When treated lumber is specified, it is recommended that only lumber that has been pressure treated with salt preservatives be specified. Lumber treated with any of the wood preservatives such as, Creosote, Pentachlorophenol, Copper Naphthenate and Copper 8-quinolinolate will adversely affect the spray foam and coating when in direct contact and are, therefore, **unacceptable**.

If non-treated lumber is to be specified, it must be stored to protect from moisture sources. A seal should be provided between the non-treated lumber and a concrete or gypsum substrate (similar to a sill sealer).

3. Methods used to fasten the nailer vary with building conditions; however, it is essential that secure attachment of durable stock be accomplished. Factory Mutual Loss Prevention Data Bulletin 1-49 (Perimeter Flashing) contains options for the spacing and sizing of fasteners based on the project wind zone.
 4. Wood nailers are not covered by the Carlisle warranty.
- Wood nailers that are anchored to steel, wood or masonry decking should not be less than 2" X 6" nominal (minimum 1-1/2" X 5-1/2").
 - Wood nailers should be Douglas Fir, Southern Yellow Pine or of wood having similar decay resistant properties.

Attachment to Masonry Walls

When fastening to a masonry wall, a 1/2 inch diameter anchor bolt is placed 48 inches on center at an 8 inch minimum depth (12 inches minimum when masonry walls are composed of lightweight aggregate or cinder) as shown in **Figure 1**. Each anchor bolt is positioned (staggered if the wood nailer is wider than 6 inches) in a block core or air space and tightly filled with concrete to the depth of the bolt.

Note: Plastic parts must not be used with masonry anchors.

FMG has specific requirements concerning filling of cores or voids in the top course of cinder blocks.

For example:

Projects requiring 75-psf or 90-psf ratings - fill the entire top course.

Projects requiring 60-psf ratings - fill only required where anchor bolts are positioned (48 inches on center in the field, 24 inches on center at roof corners).

At outside corners, the fastening density must be increased within the first 8 feet in each direction by positioning anchor bolts 24 inches on center.

An alternate method may be used by installing 3/8 inch diameter anchor bolts spaced 32 inches apart. For outside corners, bolts are fastened 16 inches apart, 8 feet from each side of the corner. If additional wood nailers are needed, refer to **Figure 5** for attachment of additional wood nailers.

Attachment to Steel and Wood Decking

- Penetration of the fasteners should be to the top flutes only. The fasteners must be staggered as shown in **Figure 2**. Consult the Steel Deck Institute for separation requirement if treated nailers are used.
- The staggered fastening pattern should be increased within 8 feet from outside corners as shown in **Figure 3A**.
- If the perimeter nailer is to be secured to a steel angle, anchor bolts must be positioned at 48 inch centers as show in **Figure 4**.
- On wood decks, the staggered fastening pattern with galvanized steel screws should be utilized as shown in **Figure 2**.

Caution: Attention should be paid to the FMG requirement which calls for galvanized steel washers (minimum 5/8 inch outside diameter) to be used in conjunction with galvanized screws. This requirement is not recognized in most cases and most often forgotten.

Attachment of Additional Wood Nailers

- When additional wood nailers are required, they must be attached with galvanized nails or lag screws that penetrate into the bottom nailer at 1-1/4 inches using a staggered fastening pattern in two rows at 24 inches apart as shown in **Figure 5**.
- The increased fastening density within 8 feet from outside corners is still required and must comply with **Figure 3**.
- The Data Sheet also contains important information pertaining to attachment of metal fascia/edging especially for those edgings which are shop fabricated.
- Even though not emphasized in the Data Sheet, contractors should examine or question existing conditions to determine if existing wood nailers are attached in compliance with the above criteria. If not, existing wood nailers should be refastened using one of these options and additional wood nailers must be secured following **Figure 5**.

Projects where Factory Mutual is the insurance underwriter should be reviewed by the local Factory Mutual office for specific criteria.

Since wood nailers are not considered part of the Carlisle Foam and Coating System Warranty, they are not addressed in depth in the Carlisle specifications nor inspected by the Carlisle Field Service Representative. Wood nailers, however, play a major role in the performance of the roofing system and contribute to the wind uplift resistance of the roof edge which is the first line of defense during wind storms.

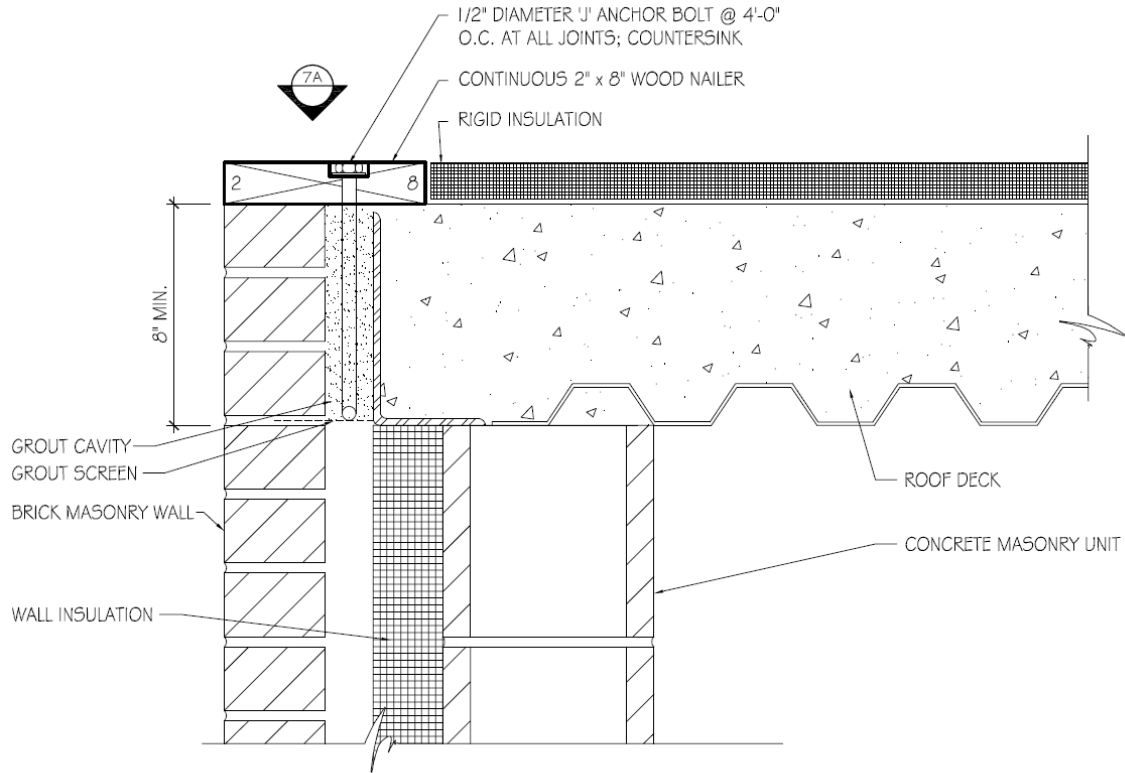

FIGURE 1 - ROOF EDGE WOOD BLOCKING - ANCHOR BOLT SECUREMENT

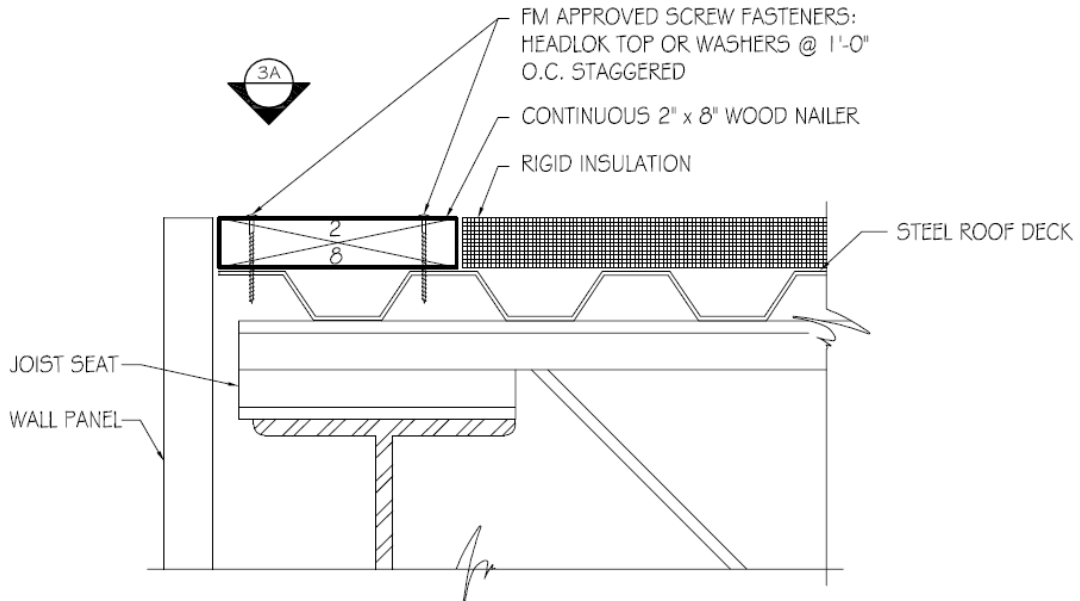

FIGURE 2 - ROOF EDGE WOOD BLOCKING - SCREW FASTENER ANCHORAGE

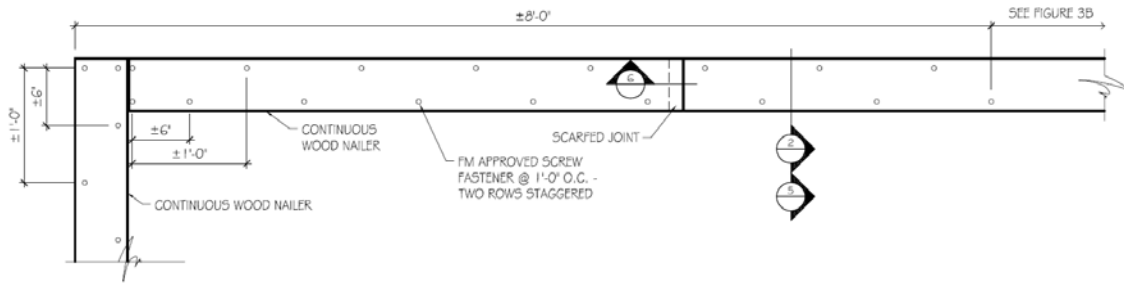

FIGURE 3A - WOOD BLOCKING CORNER ANCHORAGE 8'-0" FROM CORNER

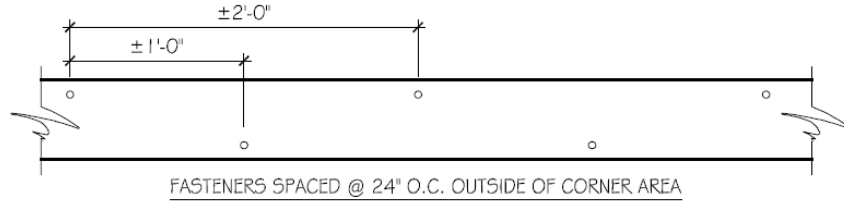

FIGURE 3B - TYPICAL ROOF EDGE WOOD BLOCKING - SCREW FASTENER ANCHORAGE

1/12" = 1'-0"

222/11

NOTES:

1. AT 8'-0" CORNERS, FASTENERS DOUBLED (12" O.C. IN EACH ROW).

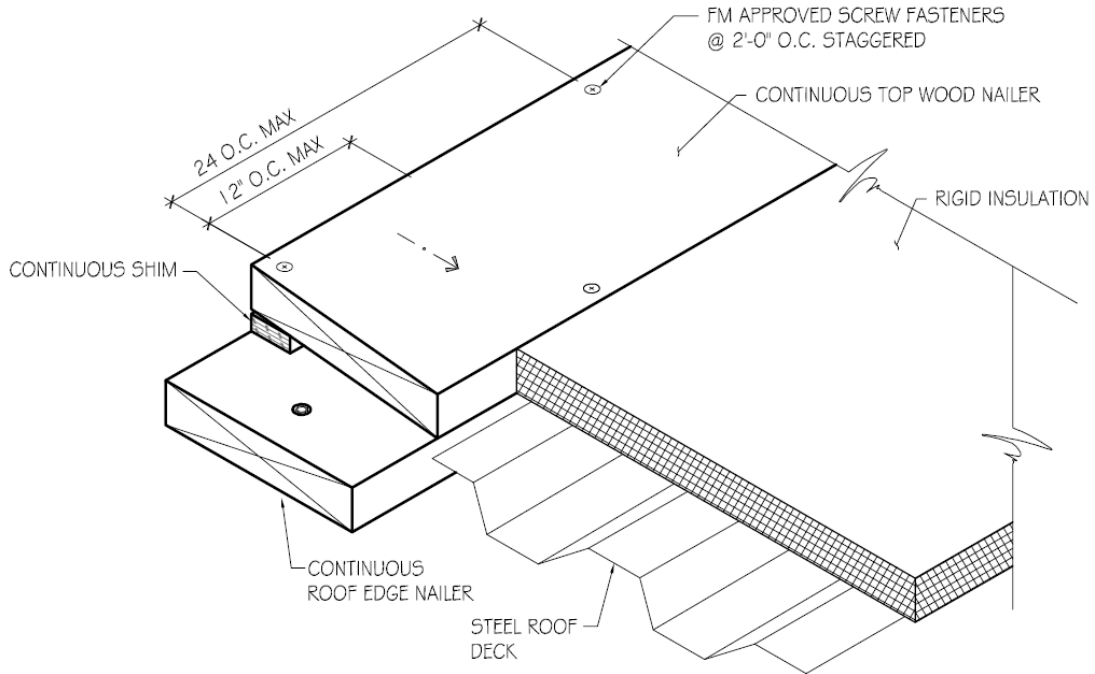

FIGURE 5

STEEL WOOD DECK SCREW FASTENERS AS FOLLOWS:

- 2 x 4 - 2 SCREW FASTENERS
- 2 x 6 - 3 SCREW FASTENERS
- 2 x 8 - 4 SCREW FASTENERS

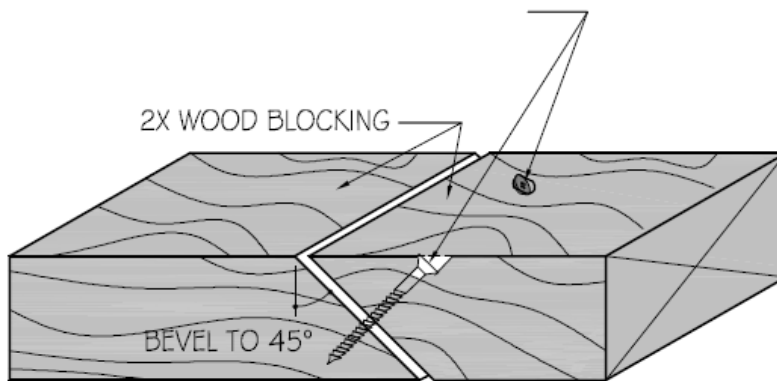

FIGURE 6 - MITERED WOOD JOINT DETAIL

NOTES:

1. 3/4" Ø ANCHOR BOLTS @ 48" O.C.
2. AT 8'-0" CORNERS: FASTENING DOUBLED (24" O.C. MAX)

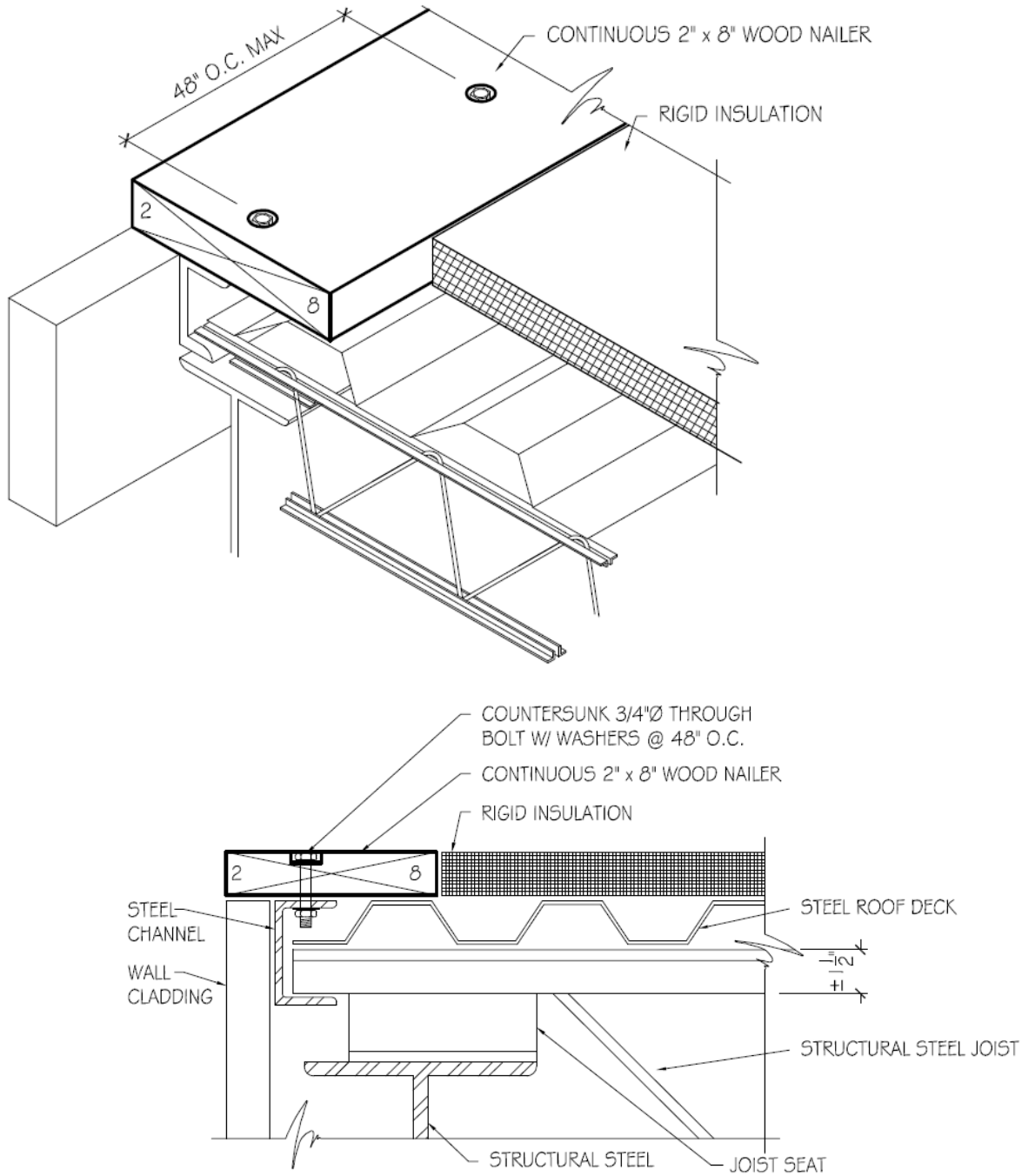

FIGURE 4 - ROOF EDGE WOOD BLOCKING - THROUGH BOLT ANCHORS

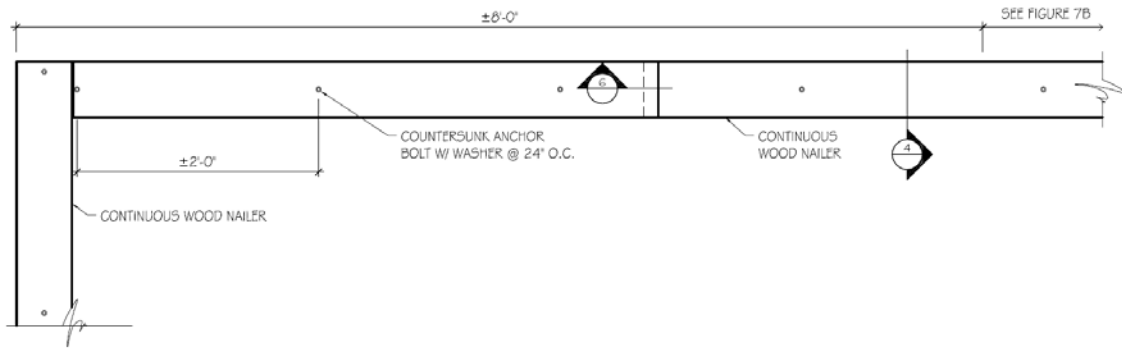

FIGURE 7A - ROOF EDGE WOOD BLOCKING @ CORNER - THROUGH BOLT ANCHORAGE 8'-0" FROM CORNER

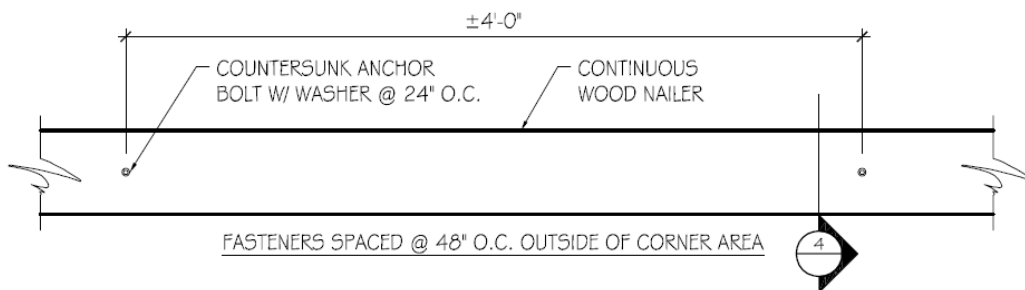

FIGURE 7B - TYPICAL ROOF EDGE WOOD BLOCKING - THROUGH BOLT ANCHORAGE

Note: These drawings show general roof diagrams. Areas that show rigid insulation can be replaced with board stock or other approved materials.

Copyright 2019 Carlisle Construction Materials Incorporated

Carlisle is Trademarks of Carlisle Construction Materials Incorporated

This Spec Supplement represents the applicable information available at the time of its publication. Owners, Specifiers and Carlisle authorized roofing applicators should consult CRFC or their Manufacturer's Representative for any information that has subsequently been made available.

DR-02-19

Metal Edging & Coping

October 2019

The information contained in this supplement serves as a criteria for Specifiers and Authorized Applicators regarding the design and installation of Carlisle Roof Foam and Coatings (CRFC) roofing systems and related products. Additional information essential for the design and installation of the Roof Systems are also included in the respective Specification for each Roof System and in the Design Reference Section of as well as the applicable Spec Supplement.

Guide for Sheet Metal Fascia Edges

(Reprinted from the NRCA Roofing Manual: Architectural Metal Flashing, Condensation and Air Leakage Control, and Reroofing - 2014)

Recommended Minimum Gauges for Fascia and Cleat ¹				
Exposed Face Without Brakes "A" Dimension	Aluminum Alloy (3003-H14)	Galvanized or Coated (G60 & G90) Steel	Stainless Steel (302 & 304)	Cleat ²
Up to 3" Face	.032"	24 ga.	26 ga.	Same gauge as fascia metal
3" to 6" Face	.040"	24 ga.	24 ga.	One gauge heavier than fascia metal
6" to 8" Face	.040"	24 ga.	24 ga.	One gauge heavier than fascia metal
8" to 10" Face	.050"	22 ga.	22 ga.	One gauge heavier than fascia metal
More than 10" Face	Add brakes to stiffen or use two-piece face	Add brakes to stiffen or use two-piece face	Add brakes to stiffen or use two-piece face	One gauge heavier than fascia metal

Recommended Profiles and Fastening for Fascia and Cleat¹

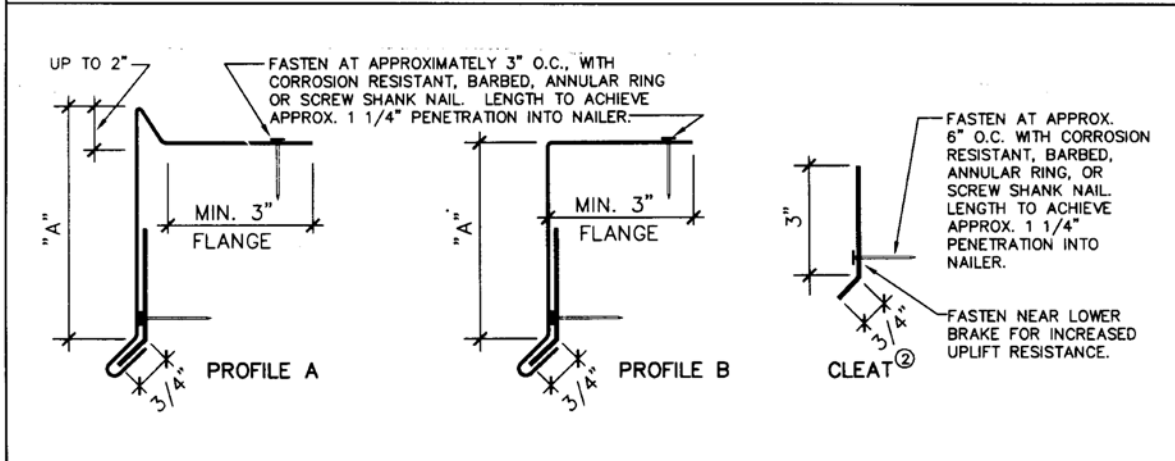

Notes:

1. Consideration must be given to wind zone and local conditions in regard to the selection of metal gauge, profile, and fastening schedule. Severe conditions or code and regulatory bodies may require more conservative designs. When using the above table, additional items should be considered, such as fastening pattern.
2. All cleats shall be continuous with lengths not to exceed 12 feet. Allow a 1/4" gap between pieces. Joints in cleat should not coincide with joints in fascia metal.
3. The securement of perimeter wood nailers, play an equally important role in the overall performance of metal fascia systems. Design Criteria for the attachment of wood nailers and associated metal edge components are also identified in the FM 1-49 Bulletin.
4. The above drawing is intended to reflect proper fastening density and fastener location when securing continuous cleats and metal edge flanges. Only metal edges with dams of sufficient height to contain entire foam thickness may be used flush at the roof level. Edges with 90 degrees drops must be elevated.

Why Specify Pre-Manufactured Roof Edges? Top 10 Reasons

Listed below are the top 10 reasons to specify Pre-Manufactured Metal Edge Systems versus Shop Fabricated Metal:

Pre-Manufactured

Shop Fabricated

Known high quality that is consistent each time and available nationwide

Unknown, possibly poor quality, that will vary by contractor and location

Snap-on details with no exposed fasteners for a clean look without leaks

Exposed fasteners that can rust, leak, and prohibit required thermal movement

Pre-punched slotted fastener holes to assure proper fastener location and to allow for thermal movement

Fasteners driven through the roof edge in the field may be spaced improperly and do not allow for thermal movement as required

Concealed internal splice plates for smooth, maintenance free joints

Frequently use exterior “band aid” splices that are unsightly and require maintenance

Factory fabricated and finished miters, end caps, and accessories provide clean, professional appearance

Miters, end caps, and accessories are field fabricated; often yielding a cobbled together appearance

Radius sections are welded to fit the project’s actual conditions providing a smooth, finished look

Segmented straight lengths, or riveted or seamed radius, give a rough, unprofessional appearance

ANSI/SPRI ES-1 tested for wind resistance per International Construction Code as is now required in many States

No testing and may not meet local building codes

Independently tested and granted a FM approval rating by the Factory Mutual Insurance Company

No testing or FM approval

Factory finishes that incorporate Kynar 500 or Hylar 5000 baked-on architectural paint to provide a finish that is warranted for up to 20 years

Field painted edge metal is often not properly prepared to assure good paint adhesion; also, many paints will not hold up to extreme UV exposure which can result in fading and chalking over time

Copyright 2019 Carlisle Construction Materials Incorporated

Kynar is a Trademark of Arkema Inc.

Carlisle is Trademarks of Carlisle Construction Materials Incorporated

This Spec Supplement represents the applicable information available at the time of its publication. Owners, Specifiers and Carlisle authorized roofing applicators should consult CRFC or their Manufacturer’s Representative for any information that has subsequently been made available.

DR CRFC DESIGN REFERENCE

D-03-19

Moisture in Concrete

October 2019

The information contained in this supplement serves as a criteria for Specifiers and Authorized Applicators regarding the design and installation of Carlisle Roof Foam and Coatings (CRFC) roofing systems and related products. Additional information essential for the design and installation of the Roof Systems are also included in the respective Specification for each Roof System and in the Design Reference Section of as well as the applicable Spec Supplement.

Moisture in Newly Poured Structural Concrete

When investigating roofs for leaks, invariably, moisture is found beneath the roof waterproofing layer, however the source of moisture is not always a roof leak. Newly poured structural concrete could be a contributor to the presence of moisture beneath a new or replacement roof.

Concrete is a mixture of several components that reaches its optimum strength through a chemical reaction induced by water. Concrete needs water to allow for flowability and workability, however water has adverse effects. Once the concrete has cured, the remaining water is considered “free water”, or moisture which is no longer consumed by the curing process. Rain and snow add moisture to roof decks and prolong the drying period. As an example, a 4” slab of structural concrete contains as much as **203 gallons of “free water”** per 1,000 square feet.



Structural Concrete Mix Ratio

The ratio for both normal-weight and lightweight Structural Concrete is one and the same:

- 10-15% Cement
- 60-75% Aggregate (Fine and Coarse)
- 15-20% Water

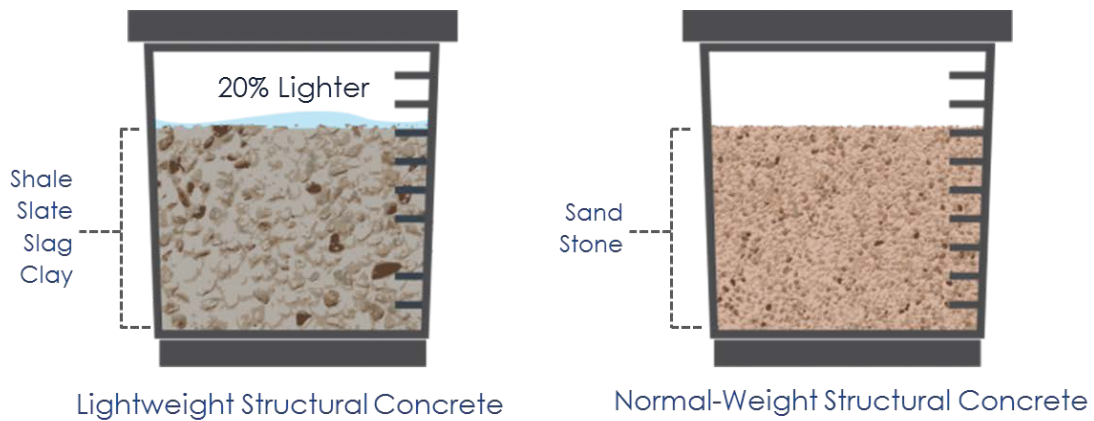

The difference is in the aggregate, with lightweight aggregate being fully saturated before being added to the concrete mix. Light weight aggregate, made up of shale, slate slag or clay, can absorb 5 to 25% of its mass with water. Normal-weight structural concrete utilizes aggregates such as sand and stone, which are not as porous and do not need to be wetted before adding to the mix.

The popularity of lightweight structural concrete is due to:

- Lower building structural cost
- Lesser density reduces the dead loads
- Environmental and Sustainability claims

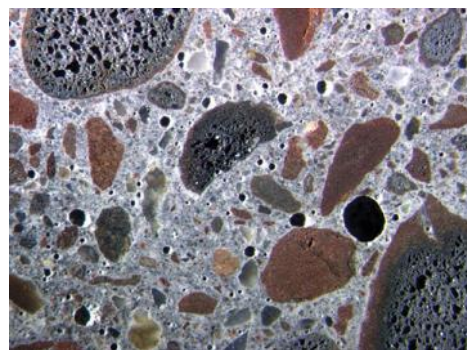

On a unit basis, lightweight structural concrete is typically more expensive than the normal-weight structural concrete.

Drying Time

To achieve a 75% Relative Humidity for normal-weight structural concrete, it will take approximately three months. To achieve the same 75% Relative Humidity for LWSC, it will take twice as long – almost six months. According to the Portland Cement Association, the dry down time for lightweight structural concrete is more than normal-weight structural concrete.

4-inch-thick Slab at 73 degree F and 50% Relative Humidity			
Water to Cement Ratio	Bottom Sealed	Bottom Surface Exposed To Water Vapor	Bottom Surface Exposed To Water
	(Over Steel Deck)	(Self-Supported Slab)	(Slab on Grade)
0.4	46	52	54
0.5	82	144	199
0.6	117	365	>365
0.7	130	>365	>365
0.8	148	>365	>365
0.9	166	>365	>365
1	190	>365	>365

Bruce Suprenant, "Moisture Movement Through Concrete Slabs", Concrete Construction

Standards for Moisture Testing

The roofing industry, has for many years, used a curing time of 28 days after the concrete is poured. However, there are test methods published by ASTM for determining the moisture content in concrete.

Qualitative tests such as the plastic sheet test, electrical resistance and/or impedance are good indicators of the presence of moisture in a given area but are not as accurate as quantitative tests.

Plastic Sheet Test



(ASTM D4263)

Electric Resistance Test



(ASTM F2659)

Electric Impedance Test



(ASTM F2659)

Quantitative tests such as moisture vapor emission rate test, surface humidity or in-situ relative humidity tests demonstrate levels of moisture present in the concrete or the rate moisture is passing through the concrete.

Moisture Vapor Emission Rate Test



(ASTM F1869)

Surface Humidity Test



(ASTM F2420)

In Situ Relative Humidity Test



(ASTM F2170)

The recommended quantitative test is the in-situ relative humidity test (ASTM F2170) which is a sleeved probe, placed in a drilled hole in the concrete and left in place for 24 hours. After the 24 hours an electronic reader is attached, and the information is read directly from the sensor. The relative humidity reading should be less than 80% at depth of approximately 40% of the thickness of the slab.



Sleeved – Instant Read

Site Considerations

The concrete pour schedule can be a factor. In phased construction, the roofing installation should be aligned with the pour schedule and Certified concrete inspectors can be utilized for moisture testing. International Concrete Repair Institute (ICRI) – concrete slab moisture testing certification program. (<http://www.icri.org/Certification/Find-CCSMTTs.asp>)

Stop Moisture Flow from The Building Interior

To facilitate down drying of the structural concrete roof deck, steps must be taken to properly vent the moisture out of the enclosed space to prevent it from migrating into the roof assembly. A well-designed air barrier system that is sealed at all penetrations and perimeters can minimize moisture-laden air leaking into the roof system.

Conclusion

- The presence of moisture is not always indicative of a roof leak.
- Lightweight Structural Concrete is wetter and takes longer to dry than standard-weight concrete.
- The Plastic Sheet Test is not a conclusive or reliable test.
- Construction sequence and roofing schedule can be a factor.

Copyright 2019 Carlisle Construction Materials Incorporated

Carlisle is Trademarks of Carlisle Construction Materials Incorporated

This Spec Supplement represents the applicable information available at the time of its publication. Owners, Specifiers and Carlisle authorized roofing applicators should consult CRFC or their Manufacturer's Representative for any information that has subsequently been made available.

Carlisle Roof Foam and Coatings Restoration Coatings Guide Spec for Acrylic

October 2019

This Guide Spec represents Carlisle Roof Foam and Coatings (CRFC) requirement for restoration of various existing roofing systems with the CRFC coatings and accessories.

A thorough investigation of the existing roof must be performed by a qualified representative of the building owner. The investigation is to assess the condition of the roof and to determine any needed repairs prior to commencing the restoration work. The CRFC Authorized applicator shall assess the condition of the roof surface to determine the level of preparation and repairs needed. The contractor shall also perform various peel/adhesion testing to determine whether the use of primers will be required.

PART I GENERAL

1.01 Description

This restoration system utilizes the application of CRFC SeamlesSEAL™ Acrylic coating after thoroughly preparing the existing roof surface to receive the new coating. An initial assessment is performed by the Authorized Applicator to evaluate the condition of the roof surface and perform adhesion tests to determine the cleaning and priming requirements. After preparation of the existing roof surface, the coating is applied to achieve the desired dry film thickness and CRFC warranty requirements. Refer to the table in the warranty 1.06 for the total minimum dry film thickness and the warranty duration.

1.02 Applicability

- A. The restoration coating is intended to enhance and extend the service life of an existing sound and watertight roof or those that may experience occasional minor leaks. The system is not suitable for the restoration of roofs which have exceeded or are approaching the end of their service life and require substantial repair.
- B. The assessment and examination of the existing roof surface to be restored shall be performed by the CRFC authorized roofing applicator and/or CRFC technical representative. The assessment and examinations shall focus on the condition of the roof, surface preparation required and the components to be restored.
- C. When in-depth investigation is needed to assess the entire existing roof system, a roof consultant or qualified representative shall be obtained by the building owner to conduct such investigation. The investigation will identify all necessary system repairs prior to commencing restoration work.

1.03 Quality Assurance

- A. Moisture surveys are strongly recommended, when moisture entrapment is suspected, on roofs installed over vapor barriers, or existing membranes that may have experienced a leak.
- B. Initial sampling and core cuts may be collected by the CRFC Authorized Applicator for moisture analysis. Detailed moisture surveys may be conducted by a qualified third-party using IR scans, nuclear scans or by taking core cuts.
- C. When applying the coating restoration system over asphaltic roofs, modified bitumen, a cap sheet or metal roofs with rust, the use of Prime-Tek Bleed Block primer is strongly recommended even if an adhesion test yields acceptable values.
 - 1. For asphaltic roofs, Prime-Tek Bleed Block primer will help prevent bleed through and the possible staining of the new coating.
 - 2. For metal roofs, Prime-Tek Bleed Block primer will inhibit future rust formation.

1.04 Restrictions and Exclusions

- A. This restoration coating system is not suitable over roofs with severely ponded conditions or those which are nearing the end of their service life and require substantial repairs.

1.05 Submittals

- A. When a CRFC restoration system warranty is considered, the Authorized Applicator shall contact CRFC representative for a project evaluation and submit to Carlisle Roof Foam and Coatings a completely executed “request for roofing warranty” along with:
 1. Project specification
 2. Preinstallation pictures
 3. Detailed roof drawing including roof penetrations, curbs, perimeter details, drains, and saddles or crickets if applicable.
 4. Peel adhesion test results

- B. A completely executed “notice of completion” must be submitted to CRFC to schedule the necessary inspection. The restoration work must be inspected and accepted by a CRFC Field Service Representative prior to issuance of the Carlisle Roof Foam and Coatings warranty, as outlined in Paragraph 1.06 “Warranty”.

- C. A sample of the CRFC Restoration Coating warranty should be made available for review by the building owner.

1.06 Warranty

- A. A restoration system warranty that covers labor and material is available for the CRFC restoration coating system for projects on commercial buildings and applies only to **products manufactured or marketed by CRFC**. Subject to the terms, conditions and limitations listed on the warranty form, CRFC will be responsible for leak repairs resulting from material and/or workmanship deficiency, for the duration of the warranty period.

Warranty Duration	Minimum Dry Film Mil Thickness
	Acrylic Coatings
10 Year	25 mils
15 Year	30 mils
20 Year	40 mils

Note: Contact CRFC for other available coatings

B. Access for Warranty Service

It shall be the owner’s responsibility to expose the roof system in the event that warranty service is required when access is impaired. Such impairment includes, but is not limited to:

1. Design features, such as window washing systems, which require the installation of traffic surface units in excess of 80 pounds per unit.
2. Any equipment, ornamentation, building service units and other top surfacing materials which are not defined as part of this specification.
3. Photovoltaic and Mounting Systems or other Rooftop equipment that does not provide CRFC with reasonable access to the roofing system for the purposes of warranty investigation and related repairs.

CAUTION: Applications such as walking decks, terraces, patios or areas subjected to conditions not typically found on roofing systems are **not** eligible for warranties.

1.07 Job Conditions

- A. Compatibility to chemical exposure will depend on type of coating used. CRFC should be contacted for verification of compatibility with chemicals or specific waste products that may come in contact with the roofing system.

Caution: Surface moisture and icy conditions are not easily detected on lighter color membranes (white, tan, gray, etc.) especially those located in cold regions. The roof surface may become extremely slippery and care shall be exercised when accessing the roof in the early morning hours (dew formation), any time after rain or during the winter. The use of sunglasses is strongly recommended when reflective coatings are used as the final coat.

1.08 Product Delivery, Storage and Handling

- A. Refer to CRFC Technical Manual for application of project specific product delivery, storage and handling requirements.

PART II PRODUCTS

2.01 General

The product components of this Carlisle Roof Foam and Coating (CRFC) Restoration Coating System are composed of CRFC products or those accepted by CRFC as compatible with this roofing system. The installation, performance or integrity of products by others, **when selected by the specifier and accepted as compatible**, is not the responsibility of CRFC and is expressly disclaimed by the CRFC Warranty.

2.02 Coatings

SeamlesSEAL Acrylic Coating is a 100% acrylic, single-component, water-based, premium quality elastomeric coating for spray, brush, or roller application. This product is designed to provide protection for a wide range of building surfaces such as roofs, vertical walls, masonry, and spray polyurethane foam (SPF) roofing systems. It is excellent for waterproofing and restoring existing roof systems, as well as for weather protection of SPF roofing systems. SeamlesSEAL Acrylic coating is applied in multiple coats, with a minimum base coat (BC) and a top coat (TC) for finishing. SeamlesSEAL TC can be used as a top or base coat. SeamlesSeal BC can be used as a basecoat but is not recommended as the top finishcoat.

2.03 Primers

Prime-Tek Epoxy Primer, Prime-Tek Acrylic General Purpose Primer (Black), Prime-Tek Bleed Block Primer (Red) and Prime-Tek Tie-in Primer (Translucent black) are all acceptable for use with this restoration coating system.

2.04 Other CRFC Products

Seal-Tek Silicone Mastic, Seal-Tek Silicone, Seal-Tek Micro, Seal-Tek Reinforcing Fabric and Prime-Tek Membrane Cleaner are used with this restoration coating.

2.05 Other Related Products

Granules, Rollers with 1/2" Nap, Brushes, 2,000 psi rated power washer, Detergent

PART III EXECUTION

3.01 General

- A. Safety Data Sheets (SDS) must always be on location during transportation, storage and application of materials. The applicator shall follow all safety regulations as recommended by OSHA, and/or other agencies having jurisdiction.
- B. Comply with building owner requirement for onsite material storage and campus regulations. Place dumpster and other equipment in areas which have been designated by the building owner.
- C. The worksite must be kept in an organized and in orderly fashion. All waste products must be removed and disposed of in accordance with local ordinances.

3.02 Surface Inspection

- A. The assessment and examination of the existing roof system to be restored shall be performed by the CRFC authorized roofing applicator or CRFC technical representative. The assessment and examinations shall focus on the condition of the roof surface and the components to be restored.
- B. When in-depth investigation is needed to assess the entire existing roof assembly. A roof consultant shall be obtained by the building owner to conduct such investigation. Investigation shall identify all necessary system repairs prior to commencing

restoration work.

Note: Consult **Attachment I - "Assessment and Investigation"** for the applicable guidelines for assessing various roof assemblies.

3.03 Substrate Preparation

- A. Do not commence with surface repairs unless all system related issues and imperfections have been addressed by the building owner and their design representative.
- B. Clean and prepare surface to receive the restoration coating. Remove all dirt, loose and flaking particles, grease, oil, laitance, pollution fallout, and other contaminants that may interfere with proper adhesion.

3.04 Surface Repair & Detail Work

Refer to CRFC Technical Manual for Restoration Coating Surface repairs and detail work.

3.05 Coating Application

- A. Do not apply coating if weather conditions will not permit complete cure (24-hour period) before rain, dew, fog or freezing temperatures occur.
- B. Using a high-pressure compressed air or an air blower, blow all dust, dirt and other contaminants off the treated roof surfaces.

3.06 Clean up

- A. Allow coating to dry before subjecting the surface to traffic. Drying conditions will vary depending on temperature and humidity levels. Consult the specific Product Data Sheets for estimated cure time.
- B. When applicable, provide owner representative with instructions on accessing the roof following the coating application.

3.07 Roof Walkways

Refer to CRFC Technical Manual for Restoration Coating Roof Walkways

END OF SECTION

Copyright 2019 Carlisle Construction Materials Incorporated

SeamlesSEAL, SeamlesSEAL Ultra, and Carlisle are Trademarks of Carlisle Construction Materials Incorporated

This Spec Supplement represents the applicable information available at the time of its publication. Owners, Specifiers and Carlisle authorized roofing applicators should consult CRFC or their Manufacturer's Representative for any information that has subsequently been made available.

Carlisle Roof Foam and Coatings Restoration Coatings Guide Spec for Silicone

October 2019

This Guide-Spec represents Carlisle Roof Foam and Coatings (CRFC) requirement for restoration of various existing roofing systems with the CRFC coatings and accessories.

A thorough investigation of the existing roof must be performed by a qualified representative of the building owner. The investigation is to assess the condition of the roof and to determine any needed repairs prior to commencing the restoration work. The CRFC Authorized applicator shall assess the condition of the roof surface to determine the level of preparation and repairs needed. The contractor shall also perform various peel/adhesion testing to determine whether the use of primers will be required.

PART I GENERAL

1.01 Description

This restoration system utilizes the application of CRFC SeamlessSEAL™ Ultra Silicone coating after thoroughly preparing the existing roof surface to receive the new coating. An initial assessment is performed by the Authorized Applicator to evaluate the condition of the roof surface and perform adhesion tests to determine the cleaning and priming requirements. After preparation of the existing roof surface, the coating is applied to achieve the desired dry film thickness and CRFC warranty requirements. Refer to the table in the warranty 1.06 for the total minimum dry film thickness and the warranty duration.

1.02 Applicability

- A. The restoration coating is intended to enhance and extend the service life of an existing sound and watertight roof or those that may experience occasional minor leaks. The system is not suitable for the restoration of roofs which have exceeded or are approaching the end of their service life and require substantial repair.
- B. The assessment and examination of the existing roof surface to be restored shall be performed by the CRFC authorized roofing applicator and/or CRFC technical representative. The assessment and examinations shall focus on the condition of the roof, surface preparation required and the components to be restored.
- C. When in-depth investigation is needed to assess the entire existing roof system, a roof consultant or qualified representative shall be obtained by the building owner to conduct such investigation. The investigation will identify all necessary system repairs prior to commencing restoration work.

1.03 Quality Assurance

- A. Moisture surveys are strongly recommended, when moisture entrapment is suspected, on roofs installed over vapor barriers, or existing membranes that may have experienced a leak.
- B. Initial sampling and core cuts may be collected by the CRFC Authorized Applicator for moisture analysis. Detailed moisture surveys may be conducted by a qualified third-party using IR scans, nuclear scans or by taking core cuts.
- C. When applying the coating restoration system over asphaltic roofs, modified bitumen, a cap sheet or metal roofs with rust, the use of Prime-Tek Bleed Block primer is strongly recommended even if an adhesion test yields acceptable values.
 - 1. For asphaltic roofs, Prime-Tek Bleed Block primer will help prevent bleed through and the possible staining of the new coating.
 - 2. For metal roofs, Prime-Tek Bleed Block primer will inhibit future rust formation.

1.04 Restrictions and Exclusions

- A. This restoration coating system is not suitable over roofs with severely ponded conditions or those which are nearing the end of their service life and require substantial repairs.

1.05 Submittals

- A. When a CRFC restoration system warranty is considered, the Authorized Applicator shall contact CRFC representative for a project evaluation and submit to Carlisle Roof Foam and Coatings a completely executed “request for roofing warranty” along with:
1. Project specification
 2. Preinstallation pictures
 3. Detailed roof drawing including roof penetrations, curbs, perimeter details, drains, and saddles or crickets if applicable.
 4. Peel adhesion test results
- B. A completely executed “notice of completion” must be submitted to CRFC to schedule the necessary inspection. The restoration work must be inspected and accepted by a CRFC Field Service Representative prior to issuance of the Carlisle Roof Foam and Coatings warranty, as outlined in Paragraph 1.06 “Warranty”.
- C. A sample of the CRFC Restoration Coating warranty should be made available for review by the building owner.

1.06 Warranty

- A. A restoration system warranty that covers labor and material is available for the CRFC restoration coating system for projects on commercial buildings and applies only to **products manufactured or marketed by CRFC**. Subject to the terms, conditions and limitations listed on the warranty form, CRFC will be responsible for leak repairs resulting from material and/or workmanship deficiency, for the duration of the warranty period.

Warranty Duration	Minimum Dry Film Mil Thickness
	Silicone Coatings
10 Year	20 mils
15 Year	25 mils
20 Year	30 mils

Note: Contact CRFC for other available coatings

B. Access for Warranty Service

It shall be the owner’s responsibility to expose the roof system in the event that warranty service is required when access is impaired. Such impairment includes, but is not limited to:

1. Design features, such as window washing systems, which require the installation of traffic surface units in excess of 80 pounds per unit.
2. Any equipment, ornamentation, building service units and other top surfacing materials which are not defined as part of this specification.
3. Photovoltaic and Mounting Systems or other Rooftop equipment that do not provide CRFC with reasonable access to the roofing system for the purposes of warranty investigation and related repairs.

CAUTION: Applications such as walking decks, terraces, patios or areas subjected to conditions not typically found on roofing systems are **not** eligible for warranties.

1.07 Job Conditions

Compatibility to chemical exposure will depend on type of coating used. CRFC should be contacted for verification of compatibility with chemicals or specific waste products that may come in contact with the roofing system.

Caution: Surface moisture and icy conditions are not easily detected on lighter color membranes (white, tan, gray, etc.) especially those located in cold regions. The roof surface may become extremely slippery and care shall be exercised when accessing the roof in the early morning hours (dew formation), any time after rain or during the winter. The use of sunglasses is strongly recommended when reflective coatings are used as the final coat.

1.08 Product Delivery, Storage and Handling

Refer to CRFC Technical Manual for application of project specific product delivery, storage and handling requirements.

PART II PRODUCTS

2.01 General

The product components of this Carlisle Roof Foam and Coating (CRFC) Restoration Coating System are composed of CRFC products or those accepted by CRFC as compatible with this roofing system. The installation, performance or integrity of products by others, **when selected by the specifier and accepted as compatible**, is not the responsibility of CRFC and is expressly disclaimed by the CRFC Warranty.

2.02 Coatings

SeamlesSEAL Ultra Silicone Coating consists of an elastomeric, liquid applied material, domestically engineered and produced. The coating can be installed in one or multiple coats. The product is suitable for application through airless spray equipment, roller, spreader bar, squeegee, or brush.

2.03 Primers

Prime-Tek Epoxy Primer, Prime-Tek Acrylic General Purpose Primer (Black), Prime-Tek Bleed Block Primer (Red) and Prime-Tek Tie-in Primer (Translucent black) are able to be used with this restoration coating system.

2.04 Other CRFC Products

Seal-Tek Silicone Mastic, Seal-Tek Silicone, Seal-Tek Micro, Seal-Tek Reinforcing Fabric and Prime-Tek Membrane Cleaner are used with this restoration coating.

2.05 Other Related Products

Granules, Rollers with 1/2" Nap, Brushes, 2,000 psi rated power washer, Detergent

PART III EXECUTION

3.01 General

- A. Safety Data Sheets (SDS) must always be on location during transportation, storage and application of materials. The applicator shall follow all safety regulations as recommended by OSHA, and/or other agencies having jurisdiction.
- B. Comply with building owner requirement for onsite material storage and campus regulations. Place dumpster and other equipment in areas which have been designated by the building owner.
- C. The worksite must be kept in an organized and in orderly fashion. All waste products must be removed and disposed of, in accordance with local ordinances.

3.02 Surface Inspection

The assessment and examination of the existing roof system to be restored shall be performed by the CRFC authorized roofing applicator or CRFC technical representative. The assessment and examinations shall focus on the condition of the roof surface and the components to be restored.

When in-depth investigation is needed to assess the entire existing roof assembly. A roof consultant shall be obtained by the building owner to conduct such investigation. Investigation shall identify all necessary system repairs prior to commencing restoration work.

Note: Consult **Attachment I - "Assessment and Investigation"** for the applicable guidelines for assessing various roof assemblies.

3.03 Substrate Preparation

- A. Do not commence with surface repairs unless all system related issues and imperfections have been addressed by the building owner and their design representative.

- B. Clean and prepare surface to receive the restoration coating. Remove all dirt, loose and flaking particles, grease, oil, laitance, pollution fallout, and other contaminants that may interfere with proper adhesion.

3.04 Surface Repair & Detail Work

Refer to CRFC Technical Manual for Restoration Coating Surface repairs and detail work.

3.05 Coating Application

- A. Do not apply coating if weather conditions will not permit complete cure (24-hour period) before rain, dew, fog or freezing temperatures occur.
- B. Using a high-pressure compressed air or an air blower, blow all dust, dirt and other contaminants off the treated roof surfaces.

3.06 Clean up

- A. Allow coating to dry before subjecting the surface to traffic. Drying conditions will vary depending on temperature and humidity levels. Consult the specific Product Data Sheets for estimated cure time.
- B. When applicable, provide owner representative with instructions on accessing the roof following the coating application.

3.07 Roof Walkways

Refer to CRFC Technical Manual for Restoration Coating Roof Walkways

END OF SECTION

Copyright 2019 Carlisle Construction Materials Incorporated

SeamlesSEAL, SeamlesSEAL Ultra, and Carlisle are Trademarks of Carlisle Construction Materials Incorporated

This Spec Supplement represents the applicable information available at the time of its publication. Owners, Specifiers and Carlisle authorized roofing applicators should consult CRFC or their Manufacturer's Representative for any information that has subsequently been made available.